



ETIBOX

Distribution Boards

Distribution boards DIDO **150**

Accessories **153**

NEW 2024

f @ in v
/etigroup

ETI
SWITCH TO
A SAFE FUTURE

ETIBOX Distribution boards DIDO

Home distribution board DIDO-E

Rated current 63 A	Rated voltage 400 V	Degree of protection IP 40
------------------------------	-------------------------------	--------------------------------------



Technical data

Degree of protection	IP 40
Colour	white
Double insulation	
Standard	IEC 62208, IEC 60670-1, IEC 60670-24
Installation temperature	-25° / +60°C
Glow wire test	650°C



Number of N - PE terminals (1,5...16mm²):

ECT/M48PT/PO	2x20 20 PE / 20 N
ECT/M1x24PT/PO	2x13 13 PE / 13 N



Flush mounted distribution board - transparent door

Type	Code No.	Number of modules	 g		Rows
ECM48PT transparent door	001100400	48	2320	1/5	4

Flush mounted distribution board - white door

Type	Code No.	Number of modules	 g		Rows
ECM48PO white door	001100402	48	2320	1/5	4

Flush mounted distribution board 1x24 modules

Type	Code No.	Number of modules	 g		Rows
ECM 1x24PT transparent door	001100401	1x24	952	1/5	1
ECM 1x24PO white door	001100403	1x24		1/5	



Flush mounted distribution board

type	Dimensions							Max. allowed power losses when Max. number of devices are installed Pde	Static load
	A	B	C	D	E	F	G		
ECM48PT/ECM48PO	676 mm	283mm	106 mm	125 mm	273 mm	656 mm	68 mm	30W	1560 g
ECM 1x24PT/ECM 1x24PO	500 mm	255 mm	106 mm	125 mm	489 mm	235 mm	68 mm	30W	2340g

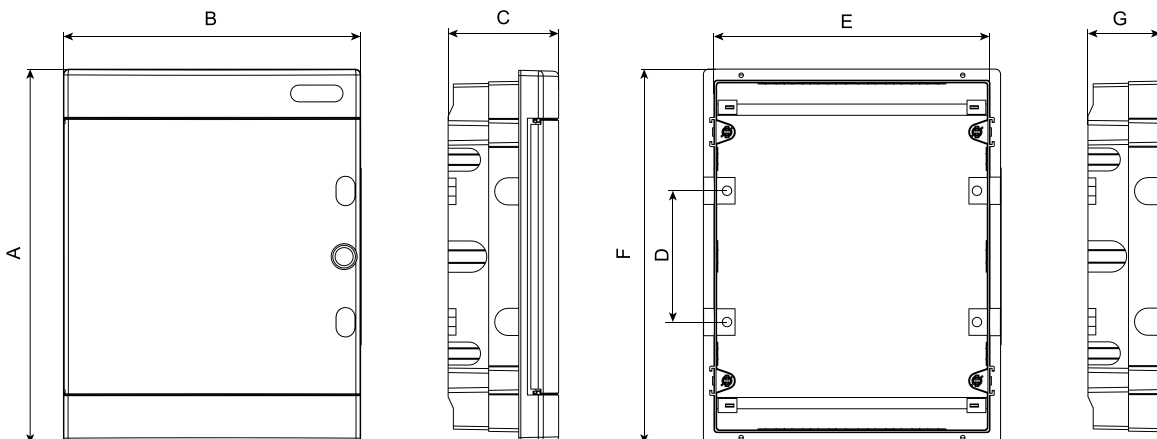

Flush mounted enclosures with super thin design DIDO ECG

Rated current 63 A	Rated voltage 400 V	Degree of protection IP 40
------------------------------	-------------------------------	--------------------------------------

Technical data



Degree of protection	IP 40
Colour	white
Double insulation	
Standard	IEC 62208, IEC 60670-1, IEC 60670-24
Installation temperature	-25° / +60°C
Glow wire test	650°C

Number of N - PE terminals (1,5...16mm²):

ECG56	2x20 20 PE / 20 N
-------	-------------------



- ECG56 and ECG70 have no extra space for PST-UNI terminals.

Flush mounted distribution board - plastic door - transparent

Type	Code No.	Number of modules	 g		Rows
ECG56PT	001100412	48+8	3650	1/1	4

*Rear side plastics conforms 650°C glow wire test (not appropriate for wooden or hollow walls - IEC 60670-24)

Flush mounted distribution board - plastic door - white

Type	Code No.	Number of modules	 g		Rows
ECG56PO	001100413	48+8	3650	1/1	4

*Rear side plastics conforms 650°C glow wire test (not appropriate for wooden or hollow walls - IEC 60670-24)

Flush mounted distribution board

Type	Dimensions					Max. allowed power losses when Max. number of devices are installed
	A	B	C	H	W	
ECG56	673 mm	306 mm	87 mm	717 mm	346 mm	60 W

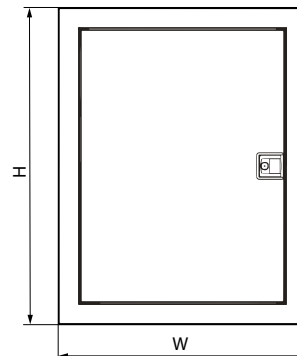
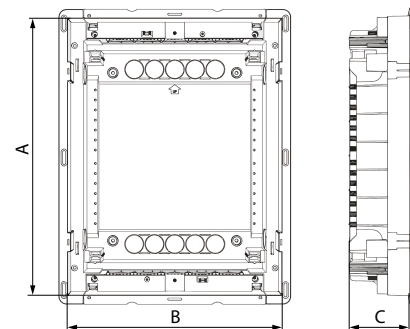

ECG

Material	Acrylonitrile butadiene styrene
Color	RAL9003
Door	Acrylonitrile butadiene styrene
Color	Transparent & white
Glow wire test	650°C
Terminal holder	Self extinguish material (Glow wire test: 960°C)
Temperature	-25°C ... +60°C
Rated voltage	AC400V
Standard	IEC 62208, IEC 60670-1, IEC 60670-24
Halogen free	✓

Enclosures for multimedia and communication device DIDO ECG MEDIA

Rated current
63 A

Rated voltage
400 V

Degree of protection
IP 30

Technical data

Degree of protection	IP 30
Colour	white
Standard	IEC 62208, IEC 60670-1, IEC 60670-24
Installation temperature	-25° / +60°C
Glow wire test	650°C



Number of N - PE terminals (1,5...16mm²):

ECG56 2x20 20 PE / 20 N

- ECG56 and ECG70 have no extra space for PST-UNI terminals.



Flush mounted multimedia distribution board - plastic door - transparent

Type	Code No.	Number of mounting plates	 g	
ECG56MEDIAPT	001100415	4	3300	1/1



*Rear side plastics conforms 650°C glow wire test (not appropriate for wooden or hollow walls - IEC 60670-24)

Distribution boards DIDO ACT



DIDO ACT

Material	ABS
Color	RAL9003
Door	styrene acrylonitrile
Color	Transparent & white
Glow wire test	650°C
Terminal holder	Self extinguish material (Glow wire test: 960°C)
Temperature	-25°C ... +60°C
Rated voltage	AC400V
Standard	IEC 62208, IEC 60670-1, IEC60670-24
Halogen free	✓

Surface mounted distribution board - plastic door - transparent

Type	Code No.	Number of modules	 g		Rows
ACT48PT	001100410	48+8	2500	1/5	4

Surface mounted distribution board - plastic door - white

Type	Code No.	Number of modules	 g		Rows
ACT48PO	001100411	48+8	2500	1/5	4

	A [mm]	B [mm]	C [mm]	D [mm]	E [mm]	Max. allowed power losses when Max. number of devices are installed
ACT48	310	650	96	219	472	60W

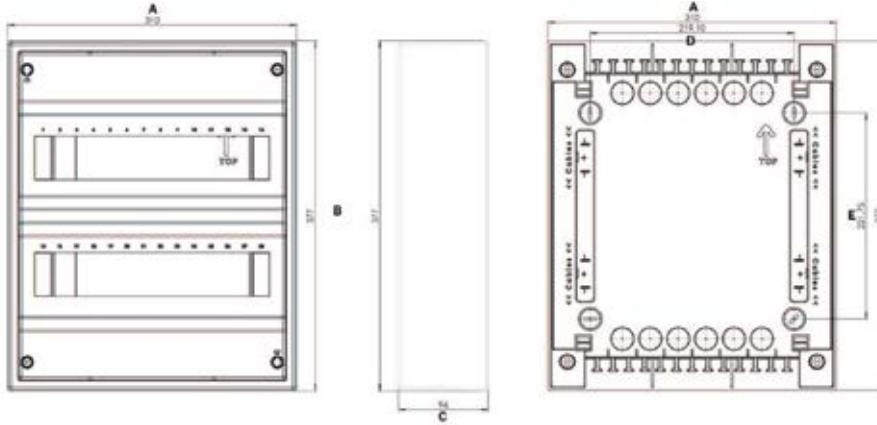

ETIBOX Accessories



Input Terminals EFB

EFB - 25 - F T - 15



- 1
- 2
- 3
- 4

1 - busbar cross-section (mm²): 25, 50.
 2 - connection type:
 F - fork type,
 P - PIN type.
 3 - cable entry:
 T - top; S - side
 4 - output length
 15...29mm



Feeding terminals EFB-25 (80A, AC 690/DC 1500V)

Type	Code No.	Cross-section [mm ²]	Type	Length [mm]	Entering		
EFB-25FT-15	002921280	6-25 mm ²	Fork	15	top	11	25
EFB-25FS-15	002921282		Fork	15	side	11	25
EFB-25PT-15	002921283		Pin	15	top	11	25
EFB-25PS-15	002921285		Pin	15	side	11	25
EFB-25FT-28	002921286		Fork	28	top	13	25
EFB-25FS-28	002921287		Fork	28	side	13	25
EFB-25PT-29	002921288		Pin	29	top	13	25
EFB-25PS-29	002921289		Pin	29	side	13	25

Feeding terminals EFB-50 (125A, AC 690/DC 1500V)

Type	Code No.	Cross-section [mm ²]	Type	Length [mm]	Entering		
EFB-50FT-15	002921281	6-50 mm ²	Fork	15	top	20	25
EFB-50PT-15	002921284		Pin	15	top	20	25

Input terminal for insulated conductor rails EFB-50 (160A, AC/DC 1000V)

Type	Code No.	Cross-section [mm ²]	Compatibility	Length [mm]		
EFB-50	002921278	6-50 mm ²	IZ (IZS) 17,8 mm	50	29	10



EFB-25FT-15



EFB-25FS-15



EFB-25PT-15



EFB-25PS-15



EFB-25FT-28



EFB-25FS-28



EFB-25PT-29



EFB-25PS-29



EFB-50FT-15



EFB-50PT-15



EFB50



3xEFB50

Dimensions

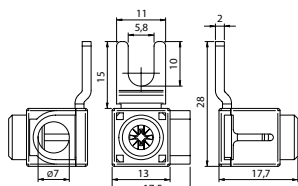

EFB-25FS-15

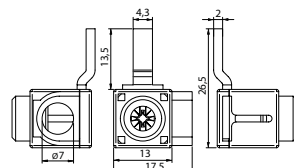

EFB-25PS-15

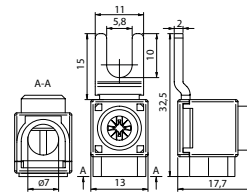

EFB-25FT-15

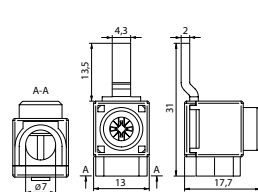

EFB-25PT-15

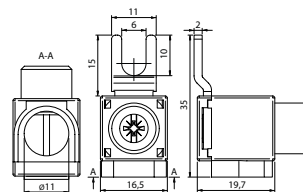

EFB-50FT-15

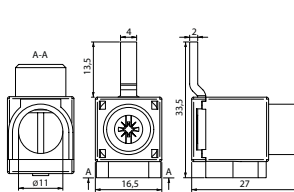

EFB-50PT-15

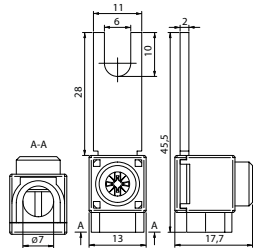

EFB-25FT-28

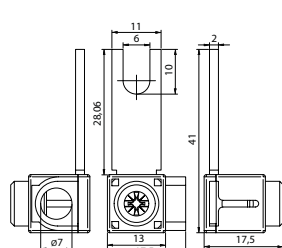

EFB-25FS-28

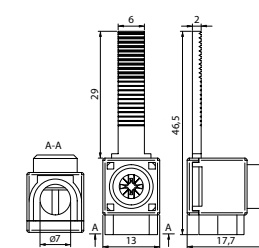

EFB-25PT-29

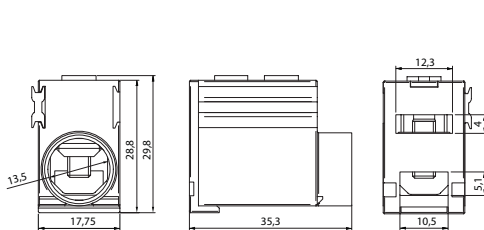

EFB-50

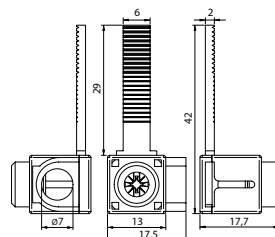

EFB-25PS-29

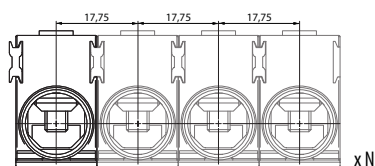

EFB-50

x N

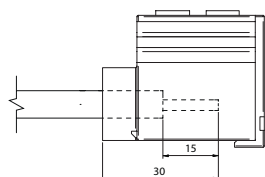

PZ2



ETIBOX

Free-standing cable distribution cabinets

- Distribution boards DIDO **824**
- SB (S Box) Double insulation enclosures IP66, IK10 **842**
- Polyester enclosures EPC (IP66) **845**
- Metal enclosures GT Type, IP66 **854**
- Free-standing cable distribution cabinets KVR **861**
- Accessories **867**

ETIBOX

Distribution boards

Home distribution board DIDO-E

Rated short-circuit capacity
6 kA

Rated current
0,5 - 63 A

Tripping characteristic
B, c, d

N/PE terminals assure fast and simple wiring.



Included special marking stickers with symbols most common for home installations



Standard set includes:

- metal DIN rail TH35 mounted in enclosure
- PE/N terminals
- mounting set with screws
- marking stickers with symbols
- cover for empty modular spaces



Possibility to add key lock to prevent unauthorized access.



Easy mounting system

Home distribution boards DIDO-E are available in two types: surface mounted and flush mounted boards, in one, two or three row design. Available with transparent or white doors. With lock set installation the board can be locked. Home distribution boards can easily be built in and already have a DIN rail installed for easier and quicker mounting of module devices. Terminal blocks for PE and N conductors are attached as standard for all distribution boards. Distribution boards correspond to condition of insulation protection and are in accordance with standard IEC60670-24.

Technical data

Degree of protection	IP 40*
Colour	white
Double insulation	<input type="checkbox"/>
Standard	IEC 62208, IEC 60670-1, IEC 60670-24
Installation temperature	-25° / +60°C
Glow wire test	650°C

*IP 30 for EC 1+1, 3+1, 3+2, ECGxxMEDIA

**Number of N - PE terminals
(1,5...16mm²):**

ECT/ECM4PT/PO	2x4	4 PE / 4 N
ECT/M8PT/PO	2x8	8 PE / 8 N
ECT/M12PT/PO	2x10	10 PE / 10 N
ECT/M18PT/PO	2x13	13 PE / 13 N
ECT/M24PT/PO	2x13	13 PE / 13 N
ECT/M36PT/PO	2x15	15 PE / 15 N
ECT48PT/PO	2x20	20 PE / 20 N
ECT/M 2x18PT/PO	2x15	15 PE / 15 N
ECT/M 3x18PT/PO	2x25	25 PE / 25 N
ECT 4x18PT/PO	2x30	30 PE / 30 N
ECT 1x24PT/PO	2x13	13 PE / 13 N
EC 1+1		-
EC 3+1		-
EC 3+2	2x4	4 PE / 4 N

- ECG14, ECG28, ECG42 have 1 additional free space to build in an extra PST-UNI terminal.
- ECG56 and ECG70 have no extra space for PST-UNI terminals.
- Double insulation not valid for ECG MEDIA

Surface mounted distribution board - IP30

Type	Code No.	Number of modules	Weight [g]	Packaging [pcs]	Rows
EC 1+1	001101044	1+1	64	1/10	1
EC 3+1	001101045	3+1	86	1/10	1
EC 3+2	001101046	3+2	170	1/5	1



Surface mounted distribution board - IP30

Type	Dimensions	Number of modules
EC 1+1	137 x 51 x 57	1 (+1)
EC 3+1	137 x 87 x 57	3 (+1)
EC 3+2	97 x 155 x 57	3 (+2)

Surface mounted distribution board - transparent door

Type	Code No.	Number of modules	Weight [g]	Packaging [pcs]	Rows
ECT4PT transparent door	001100140	4	491	1/5	1
ECT8PT transparent door	001101000	4(+4)	598	1/5	1
ECT12PT transparent door	001101001	12	952	1/5	1
ECT18PT transparent door	001101002	18	1207	1/5	1
ECT24PT transparent door	001101003	24	1444	1/5	2
ECT36PT transparent door	001101004	36	1965	1/5	3
ECT48PT transparent door	001101020	48	2200	1/5	4



ECT 8 PT

ECT 12 PT

Surface mounted distribution board - white door

Type	Code No.	Number of modules	Weight [g]	Packaging [pcs]	Rows
ECT4PO white door	001100141	4	491	1/5	1
ECT8PO white door	001101005	4(+4)	598	1/5	1
ECT12PO white door	001101006	12	952	1/5	1
ECT18PO white door	001101007	18	1207	1/5	1
ECT24PO white door	001101008	24	1444	1/5	2
ECT36PO white door	001101009	36	1965	1/5	3
ECT48PO white door	001101021	48	2200	1/5	4



ECT 48 PO

Distribution boards

Surface mounted distribution board 2x18 modules

Type	Code No.	Number of modules	Weight [g]	Packaging [pcs]	Rows
ECT 2x18PT transparent door	001101081	2x18	2414	1/5	2
ECT 2x18PO white door	001101082	2x18		1/5	

Surface mounted distribution board 3x18 modules

Type	Code No.	Number of modules	Weight [g]	Packaging [pcs]	Rows
ECT 3x18PT transparent door	001101040	3x18	2620	1/5	3
ECT 3x18PO white door	001101041	3x18		1/5	

Surface mounted distribution board 4x18 modules

Type	Code No.	Number of modules	Weight [g]	Packaging [pcs]	Rows
ECT 4x18PT transparent door	001100270	4x18	3200	1/5	4
ECT 4x18PO white door	001100271	4x18		1/5	

Surface mounted distribution board 1x24 modules

Type	Code No.	Number of modules	Weight [g]	Packaging [pcs]	Rows
ECT 1x24PT transparent door	001100280	1x24	950	1/5	1
ECT 1x24PO white door	001100281	1x24		1/5	

Flush mounted distribution board - transparent door

Type	Code No.	Number of modules	Weight [g]	Packaging [pcs]	Rows
ECM4PT transparent door	001100142	4	491	1/5	1
ECM8PT transparent door	001101010	4(+4)	681	1/5	1
ECM12PT transparent door	001101011	12	922	1/5	1
ECM18PT transparent door	001101018	18	1200	1/5	1
ECM24PT transparent door	001101012	24	1338	1/5	2
ECM36PT transparent door	001101013	36	1785	1/5	3

Flush mounted distribution board - white door

Type	Code No.	Number of modules	Weight [g]	Packaging [pcs]	Rows
ECM4PO white door	001100143	4	491	1/5	1
ECM8PO white door	001101014	4(+4)	681	1/5	1
ECM12PO white door	001101015	12	922	1/5	1
ECM18PO white door	001101019	18	1200	1/5	1
ECM24PO white door	001101016	24	1338	1/5	2
ECM36PO white door	001101017	36	1785	1/5	3

Flush mounted distribution board 2x18 modules

Type	Code No.	Number of modules	Weight [g]	Packaging [pcs]	Rows
ECM 2x18PT transparent door	001101083	2x18	2414	1/5	2
ECM 2x18PO white door	001101084	2x18		1/5	

Flush mounted distribution board 3x18 modules

Type	Code No.	Number of modules	Weight [g]	Packaging [pcs]	Rows
ECM 3x18PT transparent door	001101047	3x18	2620	1/5	3
ECM 3x18PO white door	001101048	3x18		1/5	



ECT 2x18 PT



ECT 3x18 PT



ECM 12 PT



ECM 36 PO



ECM 3x18 PO

Surface Mounted IT Distribution Boards DIDO-E MEDIA



Surface mounted, white door, perforated metal plate included

Type	Code No.	Frame size	Weight [g]	Packaging [pcs]
ECT 2x18MEDIAP0	001100210	2x18	2414	1/5
ECT 3x18MEDIAP0	001100211	3x18	2600	1/5
ECT4x18MEDIAP0	001100272	4x18	3200	1/5
ECT24MEDIAP0	001100212	24	1444	1/5
ECT36MEDIAP0	001100213	36	1965	1/5
ECT48MEDIAP0	001100214	48	2200	1/5

Accessories (Schuko socket, holder, RJ45 holder) must be ordered separately

Flush mounted distribution board

type	Dimensions							Max. allowed power losses when Max. number of devices are installed	Static load
	A	B	C	D	E	F	G		
ECM4PT/ECM4PO	232 mm	139 mm	99 mm	-	123 mm	216 mm	69 mm	>10 W	520 g
ECM8PT/ECM8PO	232 mm	211 mm	99 mm	-	201 mm	212mm	68 mm	>16 W	1040 g
ECM12PT/ECM12PO	232 mm	283 mm	106 mm	-	273 mm	212 mm	68 mm	>25 W	1560 g
ECM18PT/ECM18PO	232 mm	392 mm	106 mm	-	382 mm	212 mm	68 mm	>25 W	2340 g
ECM24PT/ECM24PO	357 mm	283 mm	106 mm	125 mm	273 mm	336 mm	68 mm	>30 W	1560 g
ECM36PT/ECM36PO	482 mm	283 mm	106 mm	125 mm	273 mm	462 mm	68 mm	>30 W	1560 g
ECM2x18PT/ECM2x18PO	357 mm	392 mm	106 mm	125 mm	382 mm	336 mm	68 mm	>30 W	2340 g
ECM3x18PT/ECM3x18PO	522 mm	392 mm	106 mm	125 mm	382 mm	502 mm	68 mm	>35 W	2340 g

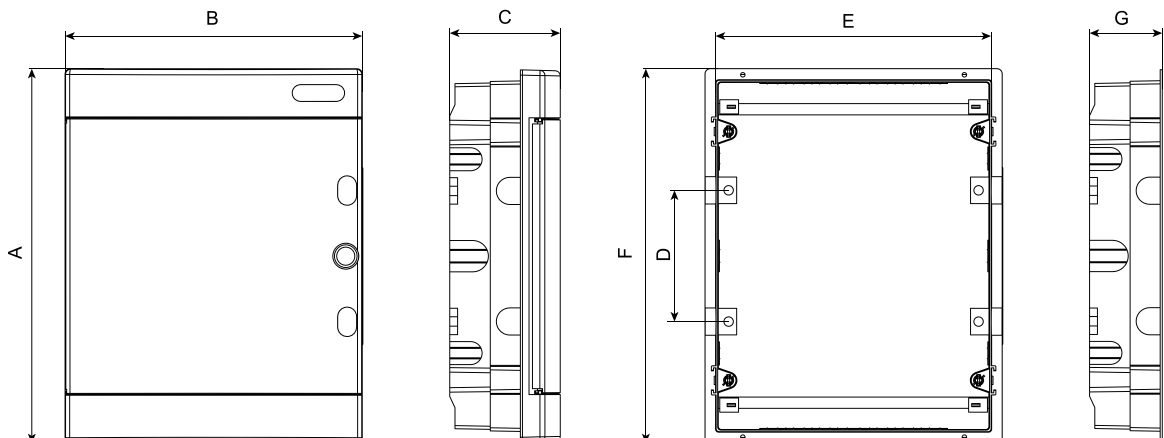

Distribution boards

Surface mounted distribution board

type	Dimensions**					Pde*	Static load
	A	B	C	D	E		
ECT4PT/ECT4PO	235 mm	143 mm	98 mm	127 mm	46 mm	10 W	520 g
ECT8PT/ECT8PO	236 mm	287 mm	102 mm	107 mm	180 mm	16 W	1040 g
ECT12PT/ECT12PO	236 mm	287 mm	112 mm	107 mm	180 mm	25 W	1560 g
ECT18PT/ECT18PT	236 mm	396 mm	112 mm	107 mm	289 mm	25 W	2340 g
ECT24PT/ECT24PO	361 mm	287 mm	112 mm	232 mm	180 mm	30 W	1560 g
ECT36PT/ECT36PO	485 mm	287 mm	112 mm	357 mm	180 mm	30 W	1560 g
ECT48PT/ECT48PO	652 mm	287 mm	112 mm	482 mm	180 mm	35 W	1560 g
ECT2x18PT/ECT2x18PO	361 mm	396 mm	112 mm	232 mm	289 mm	30 W	2340 g
ECT3x18PT/ECT3x18PO	526 mm	396 mm	112 mm	357 mm	289 mm	35 W	2340 g
ECT4x18PT/ECT4x18PO	651 mm	396 mm	112 mm	482 mm	289 mm	40 W	2340 g
ECT1x24PT/ECT1x24PO	236 mm	503 mm	112 mm	107 mm	396 mm	30 W	2340 g

* Max. allowed power losses when Max. number of devices are installed

**Sizes are also valid for IT distribution boards DIDO-E MEDIA: ECT...MEDIA

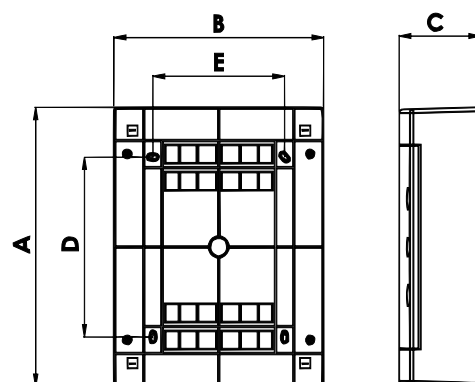

Accessories DIDO-E

Accessories DIDO ECT & ECM

Type	Description	Code No.	Weight [g]	Packaging [pcs]
ECMECT-L2K	Metal lock with 2 keys	001100203	50	1
PST-UNI	2x15 add-on terminal	001101051	100	1/25
MP-E	Modular cover - white (12 modules)	001101052	26	10/500
M20	Rubber gland M20	001101054	10	50/3000
M25	Rubber gland M25	001101055	12	50/2000
M32	Rubber gland M32	001101056	16	25/1000
M40	Rubber gland M40	001101057	20	25/600
ECMEDIA-2xSCH	Double schuko socket with holder	001100201	50	1
ECMEDIA-RHOLD	Device (router or modem) holder	001100202	50	1
ECMEDIA-RJ	RJ45 connector holder, 12 ports	001100206	100	1

* PST-UNI is an extra insulating terminal (2 x 15) that can be mounted into 12, 24, 28, 36, 42, 48 and 56 module distribution boards

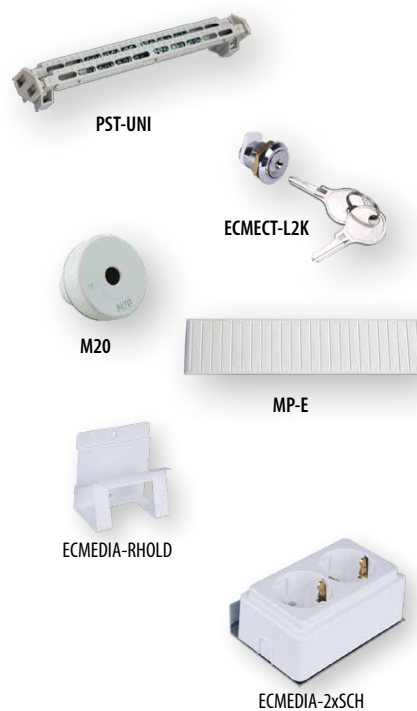

Replacement door for ECT/ECT MEDIA and ECM/ECM MEDIA

Number of modules	Compatibility	Code No.	Code No. (white door)	Weight [g]	Packaging [pcs]
8	ECT/ECM 8	001101100	001101105	90	1/50
12	ECT/ECM 12	001101101	001101106	100	1/50
18	ECT/ECM 18	001101102	001101107	150	1/50
24	ECT/ECM 24	001101103	001101108	230	1/50
36	ECT/ECM 36	001101104	001101109	350	1/40
36	ECT/ECM 2x18	001101141	001101140	360	1/40
48	ECT/ECM 48	001101120	001101121	460	1/30
54	ECT/ECM 3x18	001101148	001101147	600	1/20



...PT



...PO

Flush mounted enclosures with super thin design (metal or plastic door) DIDO ECG

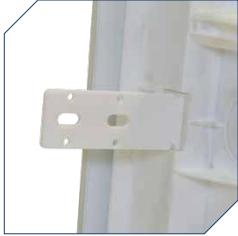

Included mounting set for all kind of walls.



Front mask sealing possibility



Special hinge system provides left or right door opening.

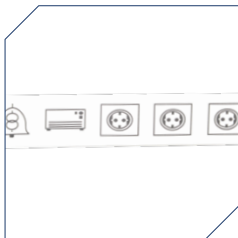

Marking sticker with symbols



Possible to add key lock



N/PE terminals included



Standard set includes:

- metal DIN rail TH35
- PE/N terminals
- mounting set with screws for all kinds of walls (concrete, hollow, wooden...)
- marking stickers with symbols
- cover for empty modular spaces



Possible to mechanically connect two ECG enclosures side by side with special metal bracket.



Distribution boards

Description

DIDO ECG are flush-mounted compact distribution boxes. They are suitable for installation in homes, schools and commercial buildings.

Main characteristics:

- // Class II, double insulated
- // Cable entrance from top or bottom
- // Device cover with opening for 12 modules per row + 2 blended (can be removed). Can be sealed
- // Thin design, 88mm depth in wall and 7mm outside the wall.
- // Color: White RAL 9003 with allowed difference $\Delta E = 2,15$

Enclosures are completely assembled with all necessary parts, such as:

- // DIN rail
- // Insulated terminals, neutral and ground
- // Covers for free space
- // Needed installation accessories for concrete and hollow walls
- // Instruction manual

Technical data

Degree of protection	IP 40*
Colour	white
Double insulation	<input type="checkbox"/>
Standard	IEC 62208, IEC 60670-1, IEC 60670-24
Installation temperature	-25° / +60°C
Glow wire test	650°C

*IP 30 for EC 1+1, 3+1, 3+2, ECGxxMEDIA

Number of N - PE terminals (1,5...16mm²):

ECG14	2x10 10 PE / 10 N
ECG28	2x13 13 PE / 13 N
ECG42	2x15 15 PE / 15 N
ECG56	2x20 20 PE / 20 N
ECG70	2x30 30 PE / 30 N

- ECG14, ECG28, ECG42 have 1 additional free space to build in an extra PST-UNI terminal.
- ECG56 and ECG70 have no extra space for PST-UNI terminals.
- Double insulation not valid for ECG MEDIA

Flush mounted distribution board - metal door, white

Type	Code No.	Number of modules	Weight [g]	Packaging [pcs]	Rows
ECG14	001101025	12+2	2000	1/1	1
ECG28	001101026	24+4	2500	1/1	2
ECG42	001101027	36+6	3000	1/1	3
ECG56	001101028	48+8	3500	1/1	4
ECG70	001101029	60+10	5000	1/1	5

*Rear side plastics conforms 650°C glow wire test; enclosures conforming 850°C glow wire test according to 60670-24, demand for hollow wall installation are on page 833

Flush mounted distribution board - plastic door - transparent

Type	Code No.	Number of modules	Weight [g]	Packaging [pcs]	Rows
ECG14PT	001101180	12+2	1900	5	1
ECG28PT	001101181	24+4	2400	5	2
ECG42PT	001101182	36+6	2900	5	3

*Rear side plastics conforms 650°C glow wire test (not appropriate for wooden or hollow walls - IEC 60670-24)

Flush mounted distribution board - plastic door - white

Type	Code No.	Number of modules	Weight [g]	Packaging [pcs]	Rows
ECG14PO	001101183	12+2	1900	5	1
ECG28PO	001101184	24+4	2400	5	2
ECG42PO	001101185	36+6	2900	5	3



Enclosures for multimedia and communication device DIDO ECG MEDIA

ENCLOSURE FOR MULTIMEDIA AND COMMUNICATION DEVICES

- // Telephone connection
- // Modems and routers (for wireless use plastic door!)
- // Antenna, cable or satellite TV connection
- // Included perforated mounting plate (zinc plated steel),
- // Included installation accessories for concrete and hollow walls



Flush mounted multimedia distribution board - perforated metal door, white

Type	Code No.	Number of mounting plates	Weight [g]	Packaging [pcs]
ECG14MEDIA-I	001101156	1	2000	1
ECG28MEDIA-I	001101157	2	2500	1
ECG42MEDIA-I	001101158	3	3000	1
ECG56MEDIA-I	001101159	4	3500	1
ECG70MEDIA-I	001101179	5	5000	1

*Rear side plastics conforms 650°C glow wire test (not appropriate for wooden or hollow walls - IEC 60670-24)



Flush mounted multimedia distribution board - plastic door - transparent

Type	Code No.	Number of mounting plates	Weight [g]	Packaging [pcs]
ECG14MEDIAPT	001101186	1	2000	5
ECG28MEDIAPT	001101187	2	2500	5
ECG42MEDIAPT	001101188	3	3000	5

*Rear side plastics conforms 650°C glow wire test (not appropriate for wooden or hollow walls - IEC 60670-24)



Flush mounted multimedia distribution board - plastic door - white

Type	Code No.	Number of mounting plates	Weight [g]	Packaging [pcs]
ECG14MEDIAPO	001101189	1	2000	5
ECG28MEDIAPO	001101190	2	2500	5
ECG42MEDIAPO	001101191	3	3000	5

*Rear side plastics conforms 650°C glow wire test (not appropriate for wooden or hollow walls - IEC 60670-24)

Distribution boards

Flush mounted multimedia distribution board - perforated metal door, white

Type	Code No.	Description	Number of modules	Weight [g]	Packaging [pcs]
ECG42COMBO2/1-I	001100220	2 Media + 1 Modular row	14	3400	1
ECG56COMBO3/1-I	001100221	3 Media + 1 Modular row	14	4100	1
ECG56COMBO2/2-I	001100222	2 Media + 2 Modular rows	28	4100	1
ECG70COMBO4/1-I	001100223	4 Media + 1 Modular row	14	4900	1
ECG70COMBO3/2-I	001100224	3 Media + 2 Modular rows	28	4900	1
ECG70COMBO2/3-I	001100225	2 Media + 3 Modular rows	42	5000	1

*Rear side plastics conforms 650°C glow wire test (not appropriate for wooden or hollow walls - IEC 60670-24)

** 1x Schuko socket already included

ECG42(H)COMBO2/1-I



ECG56(H)COMBO2/2-I



ECG70(H)COMBO3/2-I

ECG56(H)COMBO3/1-I



ECG70(H)COMBO4/1-I



Flush mounted multimedia distribution board - perforated metal door, white

Type	Code No.	Description	Number of modules	Weight [g]	Packaging [pcs]
ECG42HCOMBO2/1-I	001100226	2 Media + 1 Modular row	14	3400	1
ECG56HCOMBO3/1-I	001100227	3 Media + 1 Modular row	14	4100	1
ECG56HCOMBO2/2-I	001100228	2 Media + 2 Modular rows	28	4100	1
ECG70HCOMBO4/1-I	001100229	4 Media + 1 Modular row	14	4900	1
ECG70HCOMBO3/2-I	001100230	3 Media + 2 Modular rows	28	4900	1
ECG70HCOMBO2/3-I	001100231	2 Media + 3 Modular rows	42	5000	1

* Conforms 850°C glow wire test according to IEC60670-24 for hollow wall installation

** 1x Schuko socket already included

ECG70(H)COMBO2/3-I



Distribution boards for installation in hollow walls by IEC 60670-24 DIDO-E ECG_H

Description

DIDO ECG are flush-mounted compact distribution boxes. They are suitable for installation in homes, schools and commercial buildings.

Main characteristics:

- // Class II, double insulated
- // Cable entrance from top or bottom
- // Device cover with opening for 12 modules per row + 2 blended (can be removed). Can be sealed
- // Thin design, 88mm depth in wall and 7mm outside the wall.
- // Color: White RAL 9003 with allowed difference $\Delta E = 2,15$

Enclosures are completely assembled with all necessary parts, such as:

- // DIN rail
- // Insulated terminals, neutral and ground
- // Covers for free space
- // Needed installation accessories for concrete and hollow walls
- // Instruction manual



Flush mounted distribution board with metal door

Type	Code No.	Number of modules	Weight [g]	Packaging [pcs]	Rows
ECG14H	001101160	12+2	2000	1/1	1
ECG28H	001101161	24+4	2500	1/1	2
ECG42H	001101162	36+6	3000	1/1	3
ECG56H	001101163	48+8	3500	1/1	4
ECG70H	001101169	60+10	5000	1/1	5

Conforms 850°C glow wire test according to IEC60670-24 for hollow wall installation

Enclosures for multimedia and communication device DIDO ECG_H MEDIA



Flush mounted multimedia distribution board - perforated metal door, white

Type	Code No.	Number of mounting plates	Weight [g]	Packaging [pcs]
ECG14HMEDIA-I	001100130	1	2000	1
ECG28HMEDIA-I	001100131	2	2500	1
ECG42HMEDIA-I	001100132	3	3000	1
ECG56HMEDIA-I	001100133	4	3500	1
ECG70HMEDIA-I	001100134	5	5000	1

Conforms 850°C glow wire test according to IEC60670-24 for hollow wall installation

Distribution boards

Flush mounted distribution board

type	Dimensions					Max. allowed power losses when Max. number of devices are installed
	A	B	C	H	W	
ECG14	274 mm	306 mm	87 mm	317 mm	346 mm	31 W
ECG28	399 mm	306 mm	87 mm	442 mm	346 mm	40 W
ECG42	549 mm	306 mm	87 mm	592 mm	346 mm	50 W
ECG56	673 mm	306 mm	87 mm	717 mm	346 mm	60 W
ECG70	799 mm	306 mm	87 mm	842 mm	346 mm	70 W

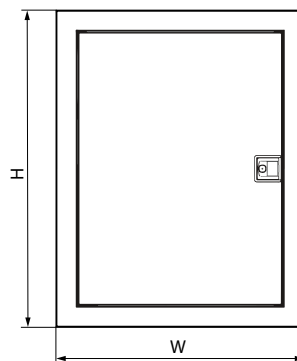
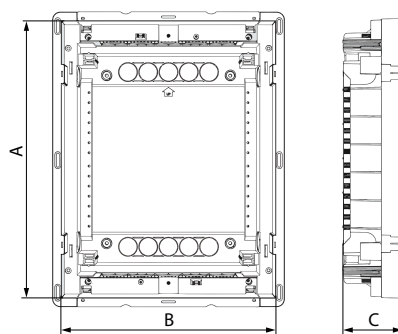

ECG

Material	Acrylonitrile butadiene styrene
Color	RAL9003
Door	Acrylonitrile butadiene styrene
Color	Transparent & white
Glow wire test	650°C
Terminal holder	Self extinguish material (Glow wire test: 960°C)
Temperature	-25°C ... +60°C
Rated voltage	AC400V
Standard	IEC 62208, IEC 60670-1, IEC 60670-24
Halogen free	✓

ECG_H

Material	Acrylonitrile butadiene styrene
Color	RAL9003
Door	Metal
Color	white
Glow wire test	850°C
Terminal holder	Self extinguish material (Glow wire test: 960°C)
Temperature	-25°C ... +60°C
Rated voltage	AC400V
Standard	IEC 62208, IEC 60670-1, IEC 60670-24
Halogen free	✓

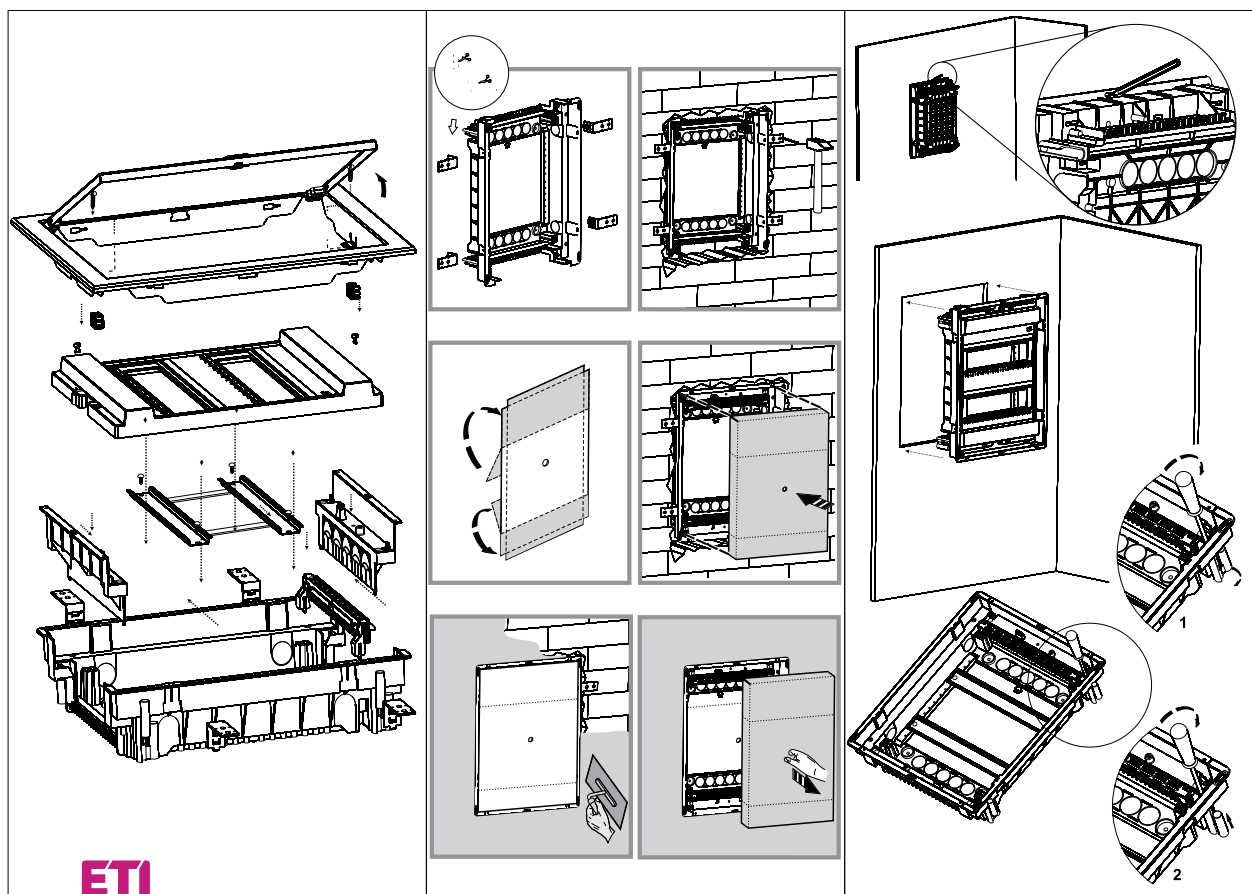

Advantages

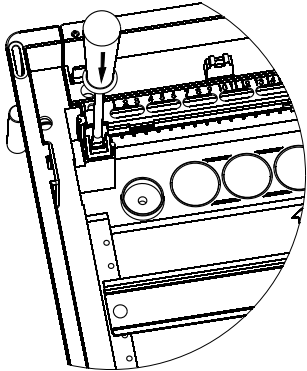

Easy terminal mounting

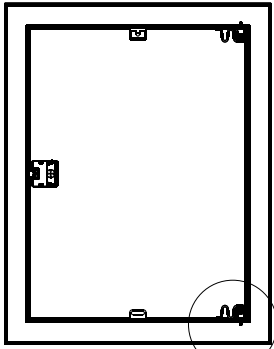

Left or right door mounting

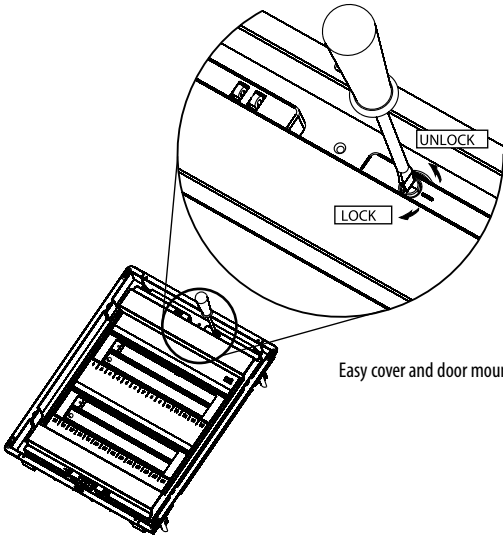
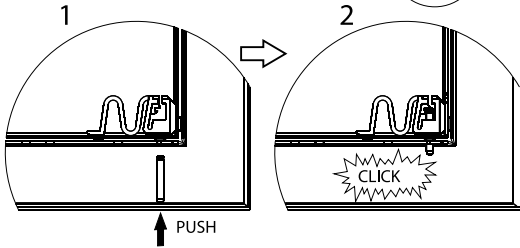

Easy cover and door mounting

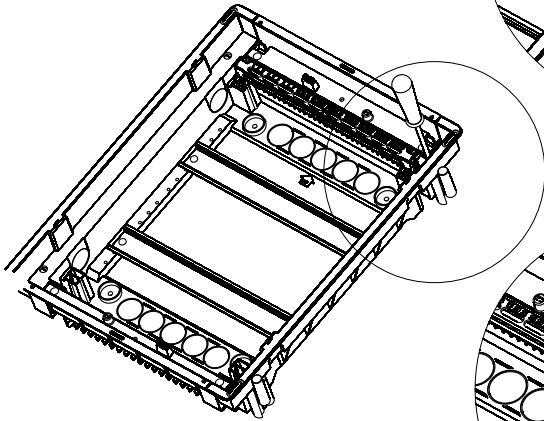

Holders for secure hollow wall installation

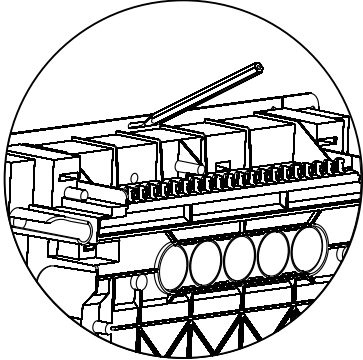

Installation marking slots for hollow walls

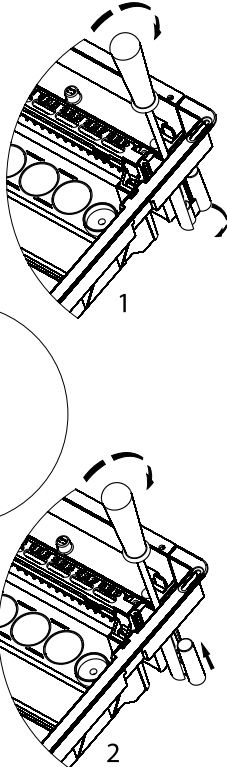

Accessories DIDO-E ECG

Accessories DIDO ECG

Type	Description	Code No.	Weight [g]	Packaging [pcs]
PST-UNI	2x15 add-on terminal	001101051	100	1/25
MP-E	Modular cover -white (12 modules)	001101052	26	10/500
ECGBRHP	Connecting brackets - horizontal, plastic	001100274	100	1
ECGBRV*	Connecting brackets - vertical	001100200	50	1
ECMEDIA-2xSCH	Double schuko socket with holder	001100201	50	1
ECMEDIA-RHOLD	Device (router or modem) holder	001100202	50	1
ECG-L2K	Metal lock, including 2 keys	001100205	50	1
ECMEDIA-RJ	RJ45 connector holder, 12 ports	001100206	100	1
ECMEDIA-PART**	Partition with 1x integrated socket	001100250	100	1
ECMEDIA-SCH	Extra (2nd) socket 16A, 250V for Partition	001100251	50	1

*1 set includes 1 pair of brackets needed to mechanically connect two distribution boards

**In one partition can be mounted 2 schuko sockets, one is already included, second can be ordered separately.
Partition with 1x schuko socket is already included in ECG_COMBO distribution board

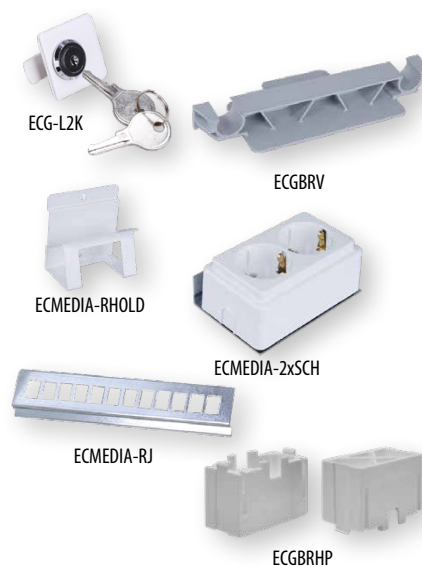

Flush mounted distribution boards with metal doors (IP40) DIDO ERP

Rated current
63 A

Rated voltage
400 V

Degree of protection
IP 40

Technical data

Protection against mechanical impacts	IK08
Rated voltage	500V
Protection class	II
Standard	PN-EN 62208:2011

Not for hollow or wooden walls, flush mounted material conforms 650°C glow wire test only!

- // Flush mounted enclosure metal door (white)
- // Colour white (RAL9016)
- // IP protection IP40
- // Equipped with TH rails, PE/N terminals, mounting brackets
- // possibility to assemble with lock with key

Enclosures are equipped with:

- // DIN rails
- // Insulated terminals, neutral and ground
- // Modular covering mask
- // Instruction manual

Assembly

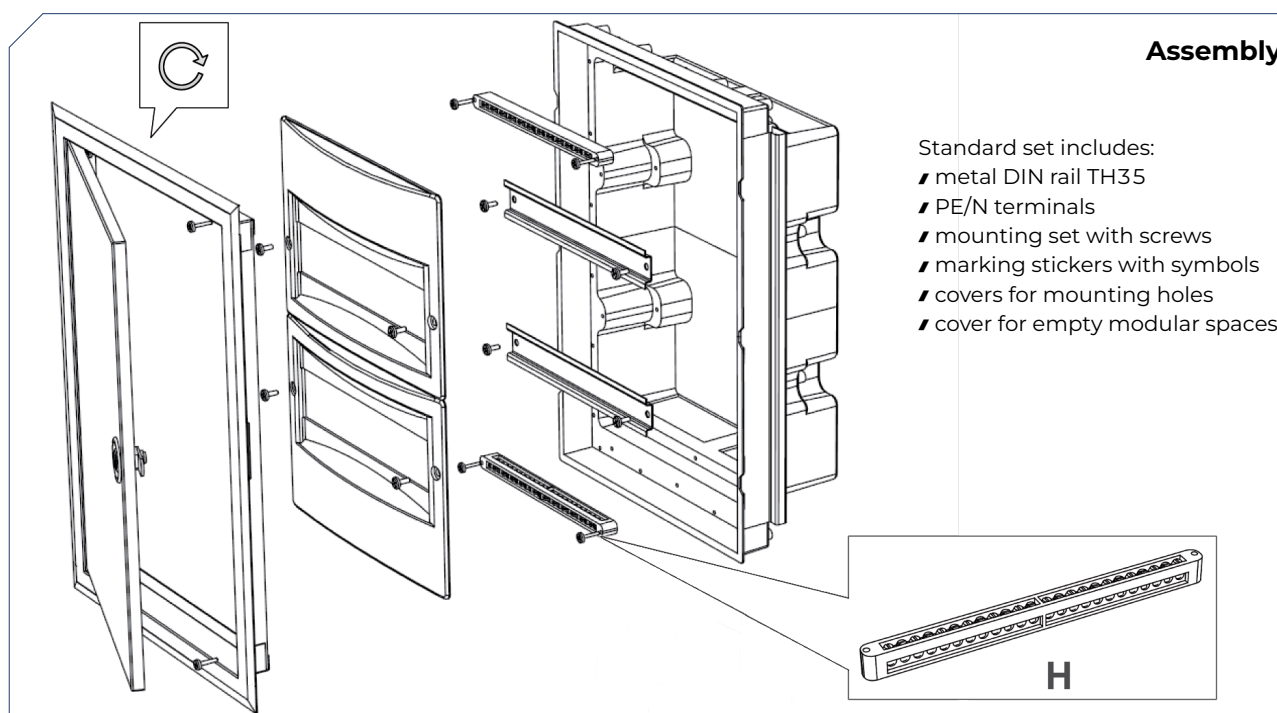

Standard set includes:

- // metal DIN rail TH35
- // PE/N terminals
- // mounting set with screws
- // marking stickers with symbols
- // covers for mounting holes
- // cover for empty modular spaces

Type designation:

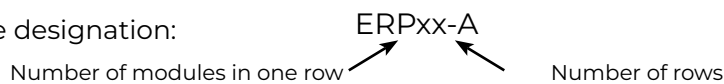

Flush mounted distribution board with metal doors

Type	Description	Code No.	Number of rows	Number of modules	Terminals PE/N	Weigh [kg]	Packaging [pcs]
ERP12-1	12 modules p/r	001101200	1	12	11/11	2,1	1
ERP12-2	12 modules p/r	001101202	2	24	1x24/2x11	3,3	1
ERP12-3	12 modules p/r	001101204	3	36	1x24/3x11	4,3	1
ERP12-4	12 modules p/r	001101206	4	48	1x24/4x11	5,2	1
ERP12-5	12 modules p/r	001101298	5	60	1x24/6x11	5,75	1
ERP12-6	12 modules p/r	001101299	6	72	1x24/6x11	6,65	1
ERP18-1	18 modules p/r	001101208	1	18	11/11	4	1
ERP18-2	18 modules p/r	001101210	2	36	1x24/2x11	5,5	1
ERP18-3	18 modules p/r	001101212	3	54	1x24/3x11	6,8	1
ERP18-4	18 modules p/r	001101214	4	72	1x24/4x11	8,2	1
ERP18-5	18 modules p/r	001101216	5	90	2x24/5x11	9,6	1
ERP18-6	18 modules p/r	001101218	6	108	2x24/6x11	11	1
ERP24-2	24 modules p/r	001101293	2	48	1x24/2x11	5,4	1
ERP24-3	24 modules p/r	001101294	3	72	1x24/3x11	7,1	1
ERP24-4	24 modules p/r	001101295	4	96	2x24/4x11	8,8	1
ERP24-5	24 modules p/r	001101296	5	120	3x24/4x11	10,4	1
ERP24-6	24 modules p/r	001101297	6	144	3x24/4x11	12,0	1

Dimensions

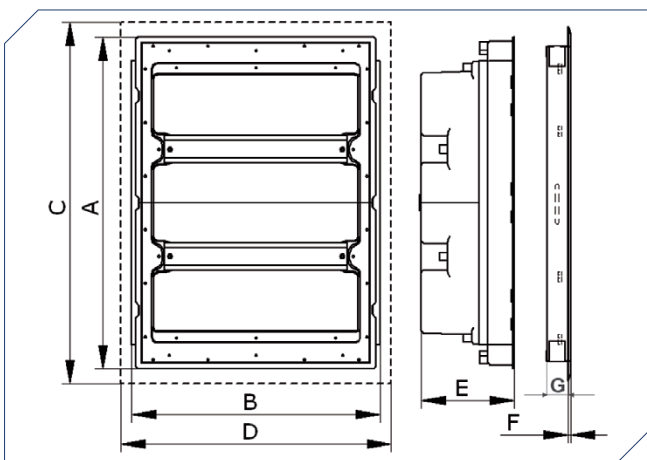

	A	B	C	D	E	F	G	H
ERP12-1	270 mm	288 mm	306 mm	326 mm	113 mm	4 mm	25 mm	2 x 5
ERP12-2	412 mm	288 mm	448 mm	326 mm	120 mm	4 mm	25 mm	2x11
ERP12-3	548 mm	288 mm	584 mm	326 mm	120 mm	4 mm	25 mm	4x11
ERP12-4	684 mm	288 mm	720 mm	326 mm	120 mm	4 mm	25 mm	4x11
ERP12-5	809 mm	288 mm	845 mm	326 mm	120 mm	4 mm	25 mm	6x12, 1x24
ERP12-6	943 mm	288 mm	980 mm	326 mm	120 mm	4 mm	25 mm	6x12, 1x24
ERP18-1	275 mm	418 mm	306 mm	451 mm	120 mm	6 mm	25 mm	2x11
ERP18-2	407 mm	418 mm	447 mm	451 mm	120 mm	6 mm	25 mm	3x11
ERP18-3	541 mm	418 mm	581 mm	451 mm	120 mm	6 mm	25 mm	3x11, 1x24
ERP18-4	675 mm	418 mm	715 mm	451 mm	120 mm	6 mm	25 mm	4x11, 1x24
ERP18-5	809 mm	418 mm	849 mm	451 mm	120 mm	6 mm	25 mm	5x11, 2x24
ERP18-6	943 mm	418 mm	983 mm	451 mm	120 mm	6 mm	25 mm	6x11, 2x24
ERP24-2	465 mm	542 mm	507 mm	575 mm	120 mm	6 mm	25 mm	1x24, 2x11
ERP24-3	600 mm	542 mm	642 mm	575 mm	120 mm	6 mm	25 mm	1x24, 3x11
ERP24-4	735 mm	542 mm	777 mm	575 mm	120 mm	6 mm	25 mm	2x24, 4x11
ERP24-5	870 mm	542 mm	912 mm	575 mm	120 mm	6 mm	25 mm	3x24, 4x11
ERP24-6	1005 mm	542 mm	1047 mm	575 mm	120 mm	6 mm	25 mm	3x24, 4x11

Distribution boards

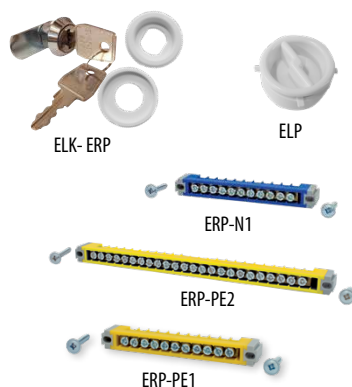

Accessories

Type	Description	Code No.	Weight [g]	Packaging [pcs]
EPLMB	Cup for sealing screw	001101278	7	100
ELK-ERP	Lock with key	001101279	56	1/10
ELP	Latch	001101280	12	1/10
ERP-N1	N terminal 11 mod.(blue)	001101281	44	1/10
ERP-N2	N terminal 24 mod.(blue)	001101282	90	1/10
ERP-PE1	PE terminal 11 mod.(yellow)	001101283	44	1/10
ERP-PE2	PE terminal 24 mod.(yellow)	001101284	90	1/10
ERP12-PM	Mounting plate EB2S/ED2S 160 3p for ERP 12	001101285	220	1
ERP18-PM	Mounting plate EB2S/ED2S 160 3p for ERP 18	001101286	250	1
ERP24-PM	Mounting plate EB2S/ED2S 160 3p for ERP 24	001101287	345	1

Distribution boards DIDO ACT

ACT distribution boards can be used in applications with wall mounted electrical installations, like containers, wooden houses. Blended cuttings on top and bottom of enclosure for entrance of various dimensions of installation channel.

Enclosures are completely assembled with all necessary parts, such as:

- // DIN rail
- // Insulated terminals, neutral and ground
- // Covers for free space
- // Needed installation accessories
- // Instruction manual

DIDO ACT

Material	ABS
Color	RAL9003
Door	styrene acrylonitrile
Color	Transparent & white
Glow wire test	650°C
Terminal holder	Self extinguish material (Glow wire test: 960°C)
Temperature	-25°C ... +60°C
Rated voltage	AC400V
Standard	IEC 62208, IEC 60670-1, IEC60670-24
Halogen free	✓

Surface mounted distribution board - plastic door - transparent

Type	Code No.	Number of modules	Weight [g]	Packaging [pcs]	Rows
ACT12PT	001100240	12+2	1300	5	1
ACT24PT	001100241	24+4	1700	5	2
ACT36PT	001100242	36+6	2100	5	3

Surface mounted distribution board - plastic door - white

Type	Code No.	Number of modules	Weight [g]	Packaging [pcs]	Rows
ACT12PO	001100243	12+2	1300	5	1
ACT24PO	001100244	24+4	1700	5	2
ACT36PO	001100245	36+6	2100	5	3



Dimensions

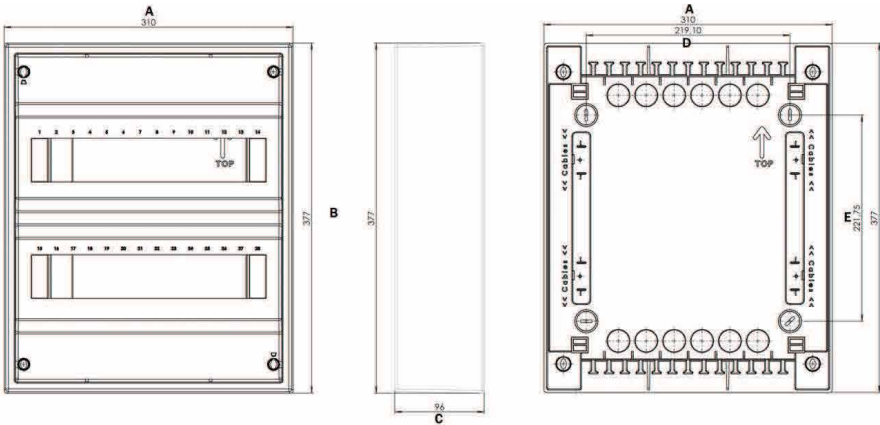

	A [mm]	B [mm]	C [mm]	D [mm]	E [mm]	Max. allowed power losses when Max. number of devices are installed
ACT12	310	251	96	96	219	30W
ACT24	310	377	96	219	222	40W
ACT36	310	502	96	219	347	60W

Modular distribution board for use outside DIDO-ECH

Rated current 63 A	Rated voltage 400 V AC/ 1500V DC	Degree of protection IP 65
------------------------------	--	--------------------------------------



Left or right door opening



- Standard set includes:
 - metal DIN rail TH35
 - PE/N terminals
 - mounting set with screws
 - marking stickers with symbols
 - covers for mounting holes
 - cover for empty modular spaces



Possible to seal enclosure, to prevent unauthorized access.

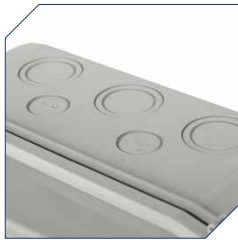

Prepared points for glands (cable entry)



Tight closing with rubber between door and housing provide IP65. Also possible to install key lock

Distribution boards

Watertight wall-mounted distribution boards apply in domestic and industry architecture for mounting modular equipment for protection (IP65) against wet, dust and another dirtiness. Enclosure is made of high thermal stability material - ASA (Acrylonitrile-Acrylic-Styrene), plastic with good dielectrical and mechanical attributes, UV resistant (colour stability). Easy and quick montage.

Main elements:

- // Bottom cover with DIN rail, PE and N bars and holes for PG cable inlets properly marked
- // Top cover with seal of the door
- // Transparent door made of polycarbonate (PC) with plastic lock (in standard) or metal lock with key (in option)

Technical data

Degree of protection	IP 65
Insulation class	II
Colour	RAL 7035
Double insulation	<input type="checkbox"/>
Standard	IEC 60670-1, IEC 60670-24
Installation temperature	-20° / +60°C
Glow wire test	650°C

Number of PE - N terminals:

ECH-4G	2x4 4 PE / 4 N
ECH-6G	2x6 6 PE / 6 N
ECH-8G	2x8 8 PE / 8 N
ECH-12PT	2x10 10 PE / 10 N
ECH-18PT	2x13 13 PE / 13 N
ECH-24PT	2x15 15 PE / 15 N
ECH-36PT	2x15 15 PE / 15 N
ECH-48PT	2x20 20 PE / 20 N

Wall mounted distribution board - ECH

Type	Code No.	Number of modules	Weight [g]	Packaging [pcs]	Rows
ECH-4G	001101060	4	460	1/5	1
ECH-6G	001101176	6	460	1/5	1
ECH-8G	001101061	8	680	1/5	1
ECH-12PT	001101062	12	1240	1/5	1
ECH-18PT	001100350	18	1700	1/5	1
ECH-24PT	001101063	24	1700	1/5	2
ECH-36PT	001101064	36	2310	1/5	3
ECH-48PT	001100304	48	3220	1/5	4

Enclosure designation

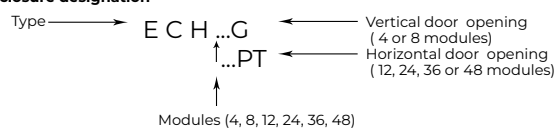

Dimensions

type	Dimensions						Max. allowed power losses when Max. number of devices are installed
	A	B	C	D	E	F	
ECH-4G	201 mm	128 mm	120 mm	-	-	140 mm	10 W
ECH-6G	201 mm	165 mm	118 mm	-	63 mm	140 mm	10 W
ECH-8G	201 mm	202 mm	120 mm	-	100 mm	140 mm	13 W
ECH-12PT	259 mm	319 mm	144 mm	-	210 mm	130 mm	16 W
ECH-18PT	259 mm	319 mm	144 mm	-	259 mm	130 mm	20 W
ECH-24PT	384 mm	319 mm	144 mm	125 mm	210 mm	255 mm	24 W
ECH-36PT	508 mm	319 mm	144 mm	125 mm	210 mm	380 mm	26 W
ECH-48PT	664 mm	319 mm	144 mm	125 mm	210 mm	505 mm	28 W

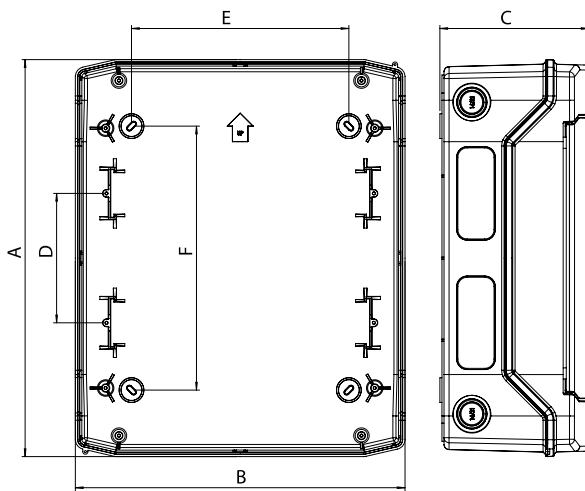

Accessories

Type	Description	Code No.	Weight [g]	Packaging [pcs]
ECH-L2K	Metal lock with 2 keys	001100204	50	1
PST-UNI	2x15 add-on terminal	001101051	100	1/25
MP-ECH	Modular cover - grey (12modules)	001101053	26	10/500

* PST-UNI is an extra insulating terminal (2 x 15) that can be mounted into 12, 24, 28, 36, 42, 48 and 56 module distribution boards



ETIBOX

SB (S Box) Double insulation enclosures IP66, IK10

Enclosures made of fiberglass-reinforced polyester RAL 7035



Fixing enclosures directly on wall (surface mounted) thru premade holes



One enclosure includes polyester mounting plate. If necessary it is possible to order additional plate separately (as replacement)



Removable mounting plate fixed by 4 screws and pressed nuts



Top cover sealed for high IP degree (IP66)



Attaching the top cover by four screws using a flat screwdriver

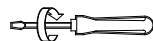

(Max. 2,1 Nm)



Door hinges as an option, must be ordered separately (Accessories). Recommended use of the silicone to keep IP protection degree (screw holes)

Description

Enclosures made of fiberglass-reinforced polyester RAL 7035, designed for extreme conditions:

- // self extinguishing 960°C , does not lead flames
- // waterproof, IP66
- // double insulation
- // halogen free
- // UV stable polycarbonate cover with gasket
- // wide temperature range -30°C / + 60 °C
- // protection against external mechanical impacts: IK10
- // easy handling & user friendly
- // suitable for PV applications, nominal voltage 1000 V DC
- // nominal current 1000A

Technical data

IP protection degree	IP 66
IK protection degree	IK10 (≤ 20 kJ)
Double insulation	
Insulation class	II
Nominal voltage	1500V DC / 1000V AC
Installation temperature	-30°C ... +60°C
Colour	Base - grey (RAL 7035) / Lid - transparent
Flame resistance (UL 94)	Base - V0 / Lid - V2
Thermal resistance	Base - 960°C / Lid - 750°C
Standard	IEC 62208

Enclosures - transparent lid, grey base RAL 7035

Type	Code No.	Number of modules	Weight [g]	Packaging [pcs]
SB-32	001102500	270x180x170	1,25	1
SB-44	001102501	360x360x170	2,90	1
SB-64	001102502	540x360x170	5,05	1

*polyester mounting plate already included and mounted in the box



They are exceptionally durable, corrosion resistant, can withstand exposure to chemicals, water and extreme condition

Dimensions

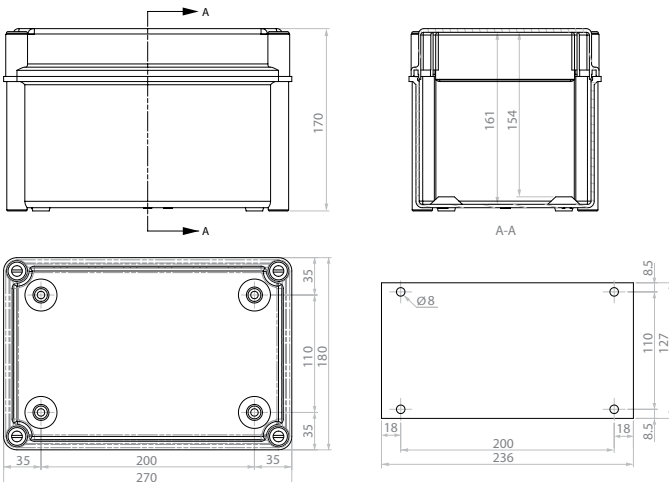

SB-32

Double insulation wall mounted enclosures

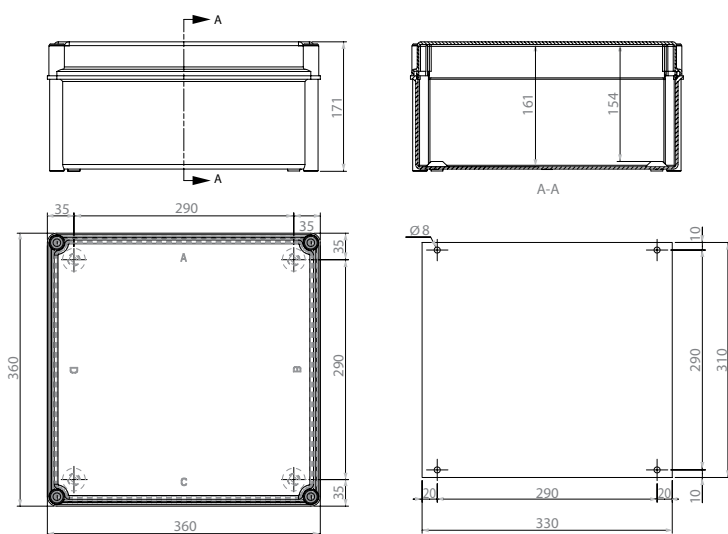

SB-44

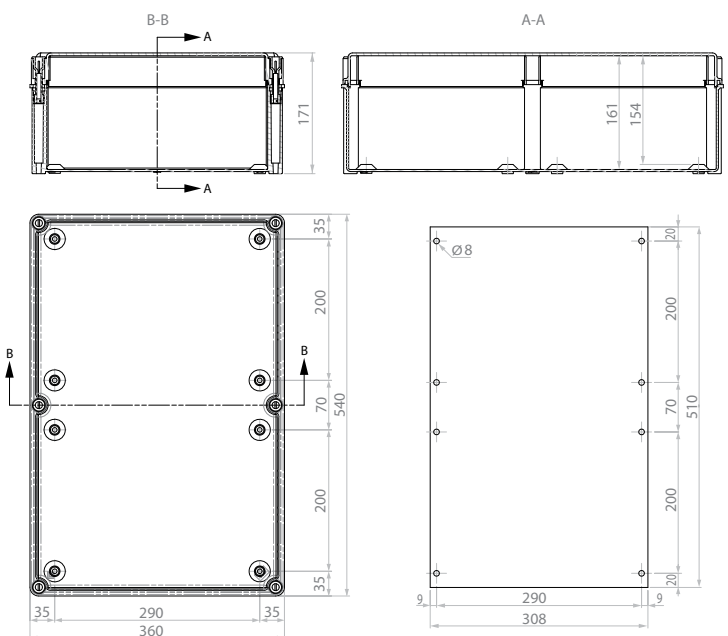

SB-64

Accessories, spare parts

Type	Code No.	Description	Weight [g]	Packaging [pcs]
SB-MP32	001102503	Mounting plate for SB-32	0,16	5
SB-MP44	001102504	Mounting plate for SB-44	0,71	5
SB-MP64	001102505	Mounting plate for SB-64	0,88	5
SB-HIN	001102507	Door Hinges	0,01	1



SB-MP.

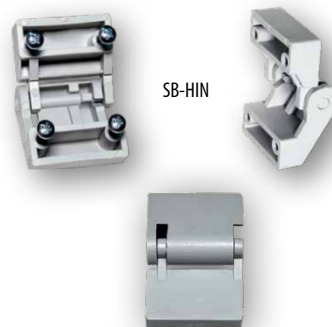

SB-HIN

ETIBOX Polyester enclosures EPC (IP66)

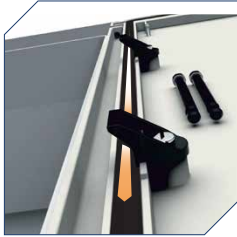

Anti blow system. With up to 3 or 4 points of pressure. The “wedges” press the rubber gasket at the door against the interior of the enclosure to assure IP66 protection.

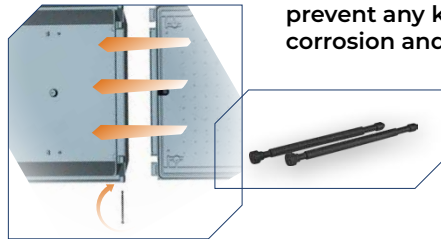

NON-METALLIC hinge pins that will prevent any kind of corrosion and rust.

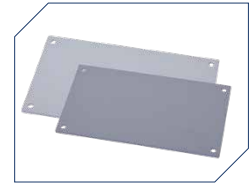

Mounting plates are not included in the package. Can be ordered additionally: polyester or metal.

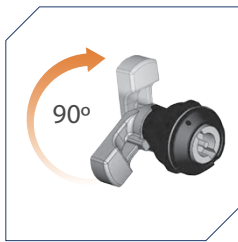

90° locking mechanism. The standard lock can be replaced by lock with key.

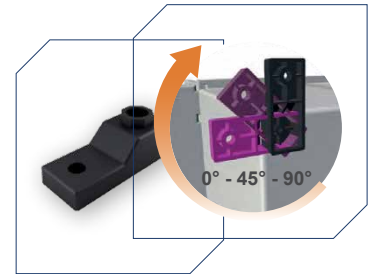

Enclosure can be directly mounted on wall or additional wall fixing lugs can be used.



Possible to connect 2 or more enclosures together (grouping) by using additional connecting flanges.



Manual installation of the hinge pins, without the need for tools. Hinge bolts allow the door to open up to 180°



Closets are designed with a Shade or Cover which protects the closet from getting water inside.



Included mounting set for installation of enclosures directly on the wall (4 screws with inserts). Due to separated installation hole, IP66 is obtained.

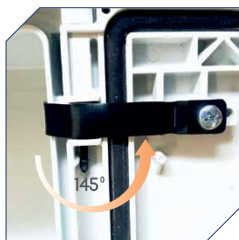

Accessory EPC-DH-145 allows limit and lock door opening angle from 180° to 145°



2 types of passive ventilation (natural air convection) systems: EPC-VDS / VDL modules



For visual control are available cabinets with window EPC-W series.















Metric or PG cable glands can be used for IP66 cable entry.

Polyester enclosures

Fiberglass Reinforced Polyester EPC Cabinets (IP66)

Description

Polyester reinforced with fiber glass enclosures provide double insulation class in IP66 protection. Can be used outside (PV systems, up to 1500VDC) or in industry applications.

	Double insulated enclosure, protection class II. Rated operational voltage 1000Vac - 1500Vdc		Excellent cabinets for outside installation and withstanding extreme climate conditions. Rain, frost, dirt... even chemical agents. They have a much higher lifespan than metallic closets.		RoHS Compliant
	Manufactured entirely without any metallic parts. WILL NOT RUST		All components made with recyclable materials and reduced waste. Abides by the European restrictions of hazardous residue RoHS		UV stable material
	IP66 grade protection against water and dust; non-hygroscopic materials.		High mechanical resistance IK-10		Color RAL7035
	Thermosetting materials do NOT vary in structure or get deformed with climate changes. However, plastic materials WILL get deformed.		UV stable material		Fire resistant at 960°, self-extinguishing material and halogen free.
	Possible grouping of enclosures by using IP66 connection flanges.		Color RAL7035		



Technical data

Protection degree	IP66
Degree of protection against external mechanical impacts	IK10, IK07 (with window)
Protection class	II
Rated operational voltage	1000 V AC, 1500 V DC
Material body/seal	fiberglass reinforced polyester / polyurethane
UV resistance	✓
Operating temperature	-30 °C ... +120 °C
Color	RAL 7035
Resistance to fire and heat	960 °C
Compliance with standards	IEC 62208

Polyester enclosures IP66 (solid door)

Type	Code No.	Description	Dimensions [mm]			Weight [kg]	Packaging [pcs]
			Height	Width	Depth		
EPC 30-25-14	001102600	Polyester enclosure IP66	300	250	140	1,93	1
EPC 40-30-20	001102601	Polyester enclosure IP66	400	300	200	3,60	1
EPC 40-40-20	001102602	Polyester enclosure IP66	400	400	200	4,35	1
EPC 50-40-20	001102603	Polyester enclosure IP66	500	400	200	5,25	1
EPC 60-40-23	001102604	Polyester enclosure IP66	600	400	230	7,13	1
EPC 60-50-23	001102605	Polyester enclosure IP66	600	500	230	7,93	1
EPC 80-30-23	001102606	Polyester enclosure IP66	800	300	230	6,40	1
EPC 80-60-30	001102607	Polyester enclosure IP66	800	600	300	12,65	1

Mounting plate not included!



Polyester enclosures IP66 (door with window)

Type	Code No.	Description	Dimensions [mm]			Weight [kg]	Packaging [pcs]
			Height	Width	Depth		
EPC-W 30-25-14	001102608	Polyester enclosure IP66 (with window)	300	250	140	2,00	1
EPC-W 40-30-20	001102609	Polyester enclosure IP66 (with window)	400	300	200	3,57	1
EPC-W 40-40-20	001102610	Polyester enclosure IP66 (with window)	400	400	200	4,30	1
EPC-W 50-40-20	001102611	Polyester enclosure IP66 (with window)	500	400	200	5,21	1
EPC-W 60-40-23	001102612	Polyester enclosure IP66 (with window)	600	400	230	7,05	1
EPC-W 60-50-23	001102613	Polyester enclosure IP66 (with window)	600	500	230	7,56	1
EPC-W 80-30-23	001102614	Polyester enclosure IP66 (with window)	800	300	230	6,40	1
EPC-W 80-60-30	001102615	Polyester enclosure IP66 (with window)	800	600	300	12,15	1



Mounting plate not included!

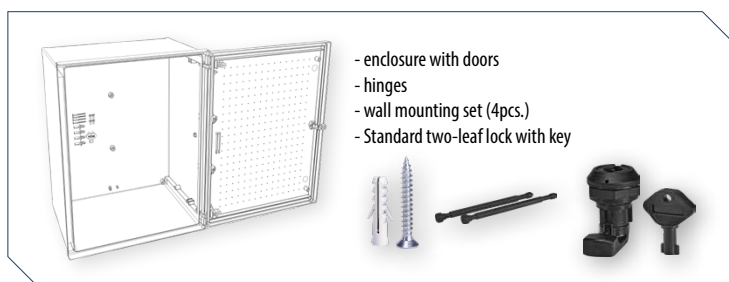

Properties	EPC/-W 30-25-14	EPC/-W 40-30-20	EPC/-W 40-40-20	EPC/-W 50-40-20	EPC/-W 60-40-23	EPC/-W 60-50-23	EPC/-W 80-30-23	EPC/-W 80-60-30
External dimensions								
Height (mm)	300	400	400	500	600	600	800	800
Width (mm)	250	300	400	400	400	500	300	600
Depth (mm)	140	200	200	200	230	230	230	300
Internal dimensions								
Height (mm)	273	373	373	473	573	573	773	773
Width (mm)	207	257	357	357	357	457	257	557
Depth (mm)	123	183	183	183	213	213	213	283
Other characteristics								
Number of locks	1	2	2	2	2	2	2	2
Number of wedges (anti-blow system)	1	1	2	2	2	2	2	2
Number of fixing points - mounting plate	4	5	5	6	6	6	4	7
Power dissipation Pde@T=40 °C	36,2	58,8	72,6	82,9	99,4	117	103	185
Weight (kg)	1,93	3,6	4,35	5,25	7,13	7,93	6,4	12,65
Mounting plate (polyester)								
Height (mm)	EPC-PMP 30-25 262	EPC-PMP 40-30 360	EPC-PMP 40-40 360	EPC-PMP 50-40 460	EPC-PMP 60-40 558	EPC-PMP 60-50 558	EPC-PMP 80-30 756	EPC-PMP 80-60 756
Width (mm)	198	248	348	348	348	448	248	548
Thickness (mm)	3	3	3	3	3	3	3	4
Weight (kg)	0,38	0,59	0,87	1,09	1,3	1,75	1,46	2,78
Mounting plate (metal)								
Height (mm)	EPC-MPP 30-25 262	EPC-MPP 40-30 360	EPC-MPP 40-40 360	EPC-MPP 50-40 460	EPC-MPP 60-40 558	EPC-MPP 60-50 558	EPC-MPP 80-30 756	EPC-MPP 80-60 756
Width (mm)	198	248	348	348	348	448	248	548
Thickness (mm)	2	2	2	2	2	2	2	2
Weight (kg)	0,79	1,3	1,9	2,2	3	3,6	3,26	6,4

Dimensions

EPC/EPC-W 30-25-14

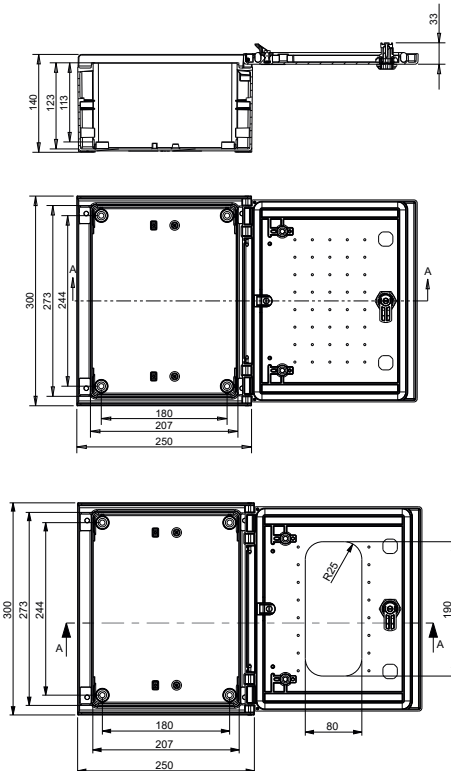

EPC/EPC-W 40-30-20

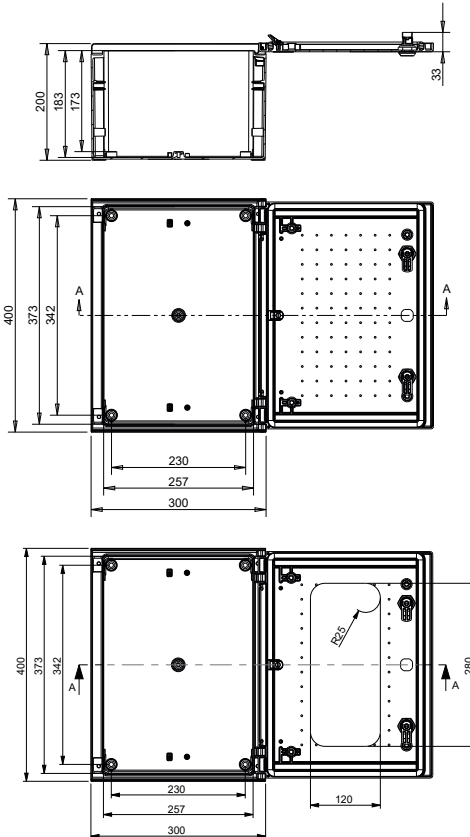

EPC/EPC-W 40-40-20

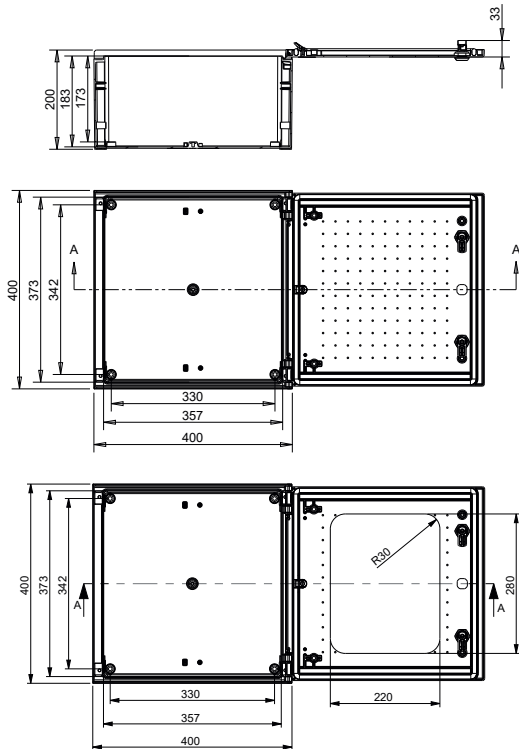

EPC/EPC-W 50-40-20

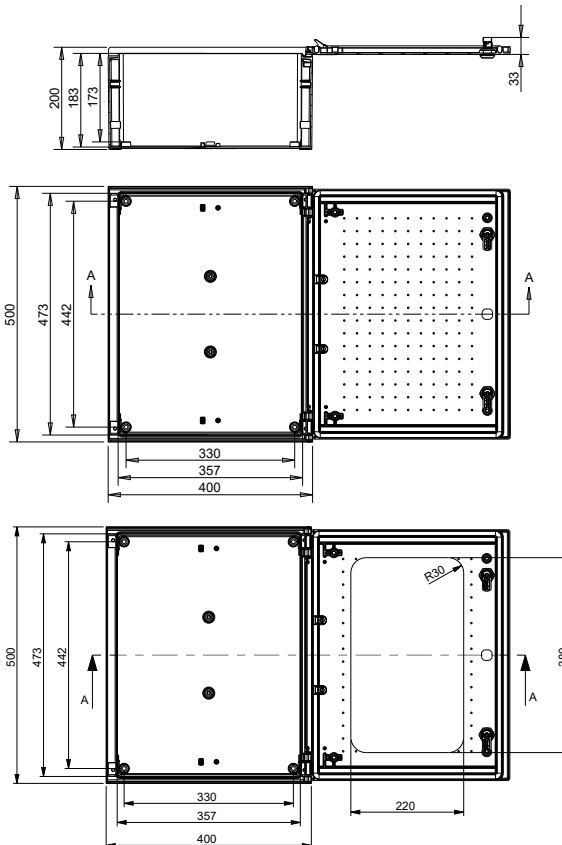

EPC/EPC-W 60-40-23

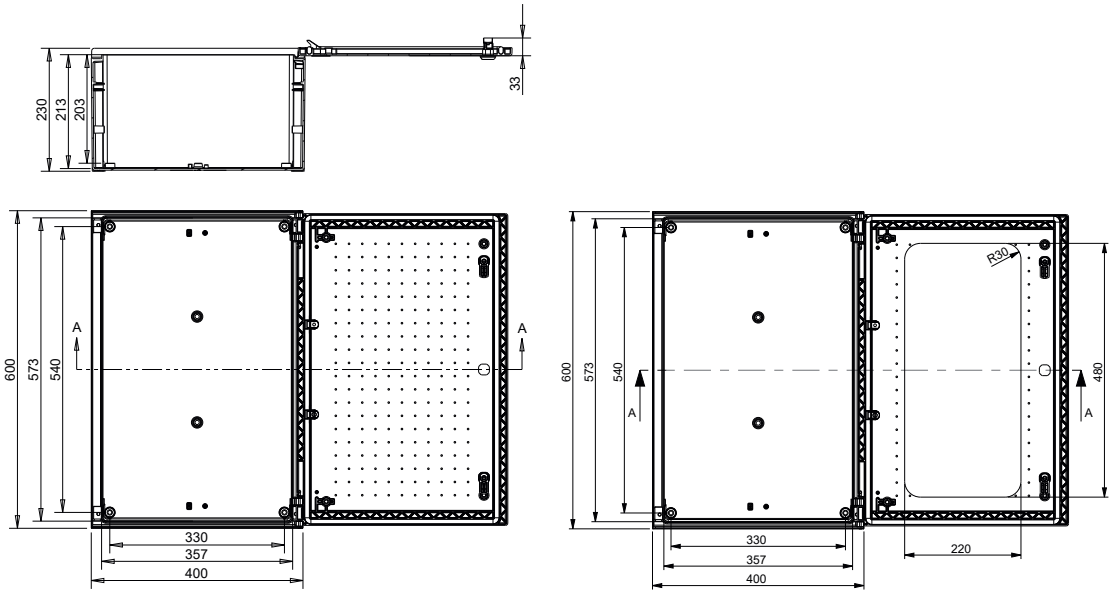

EPC/EPC-W 60-50-23

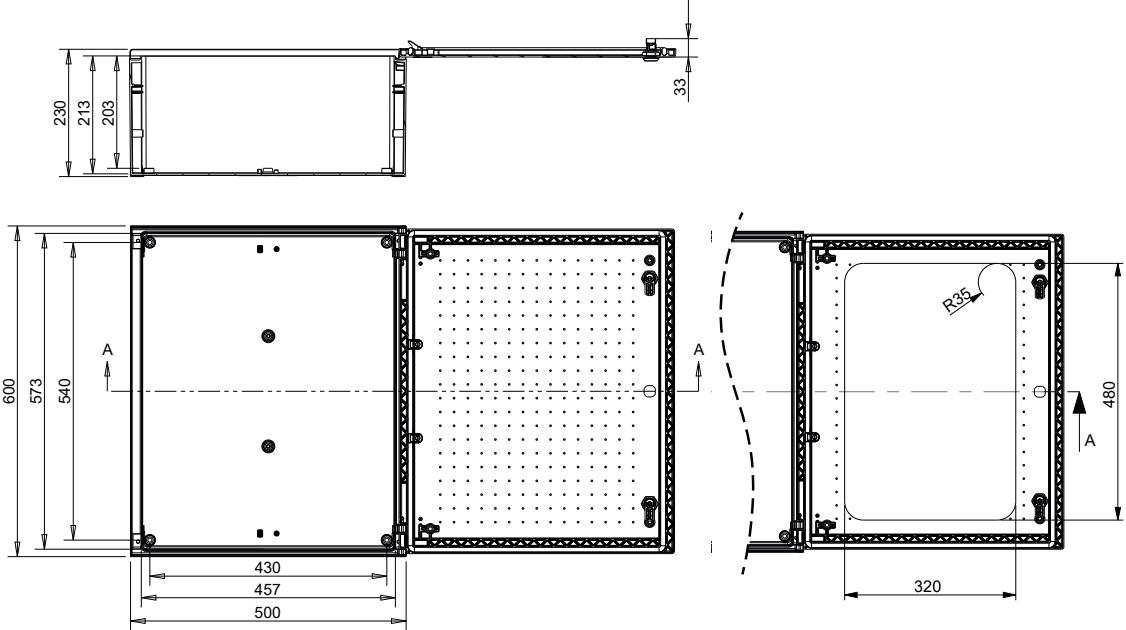

Polyester enclosures

EPC/EPC-W 80-30-23

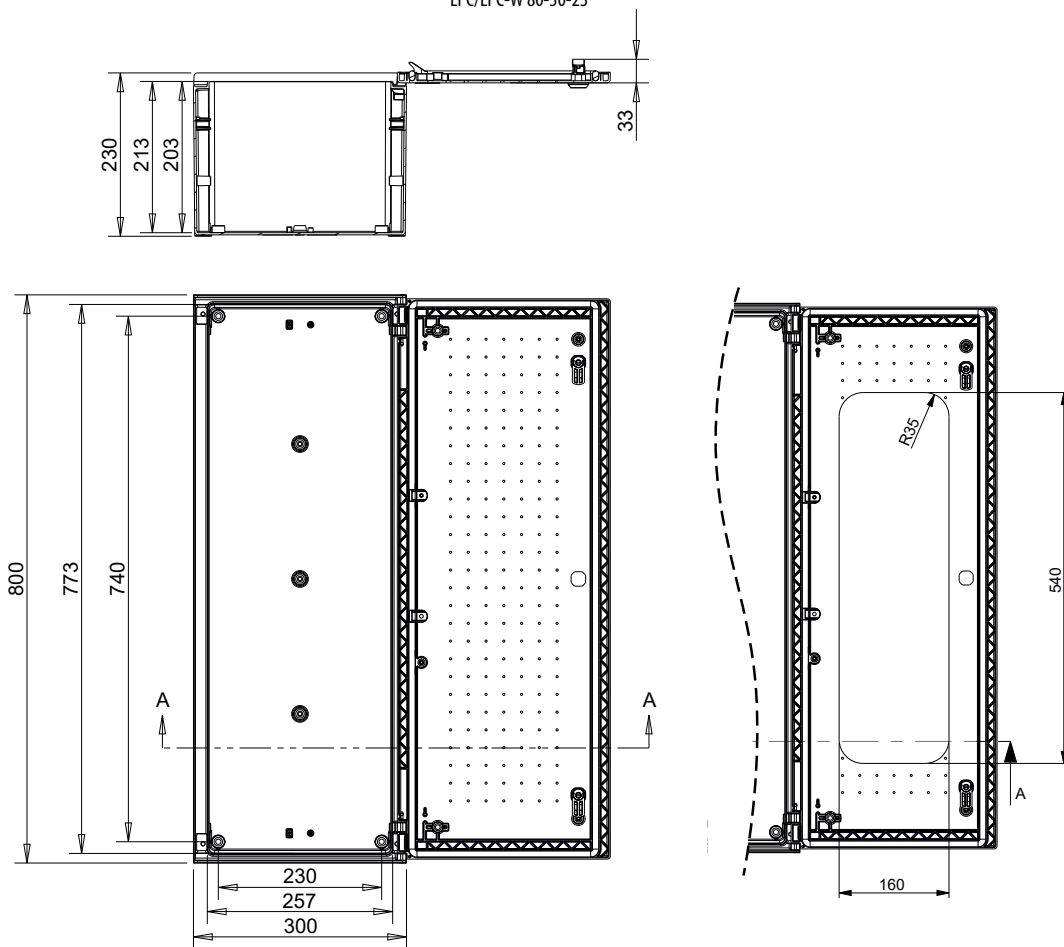

EPC/EPC-W 80-60-30

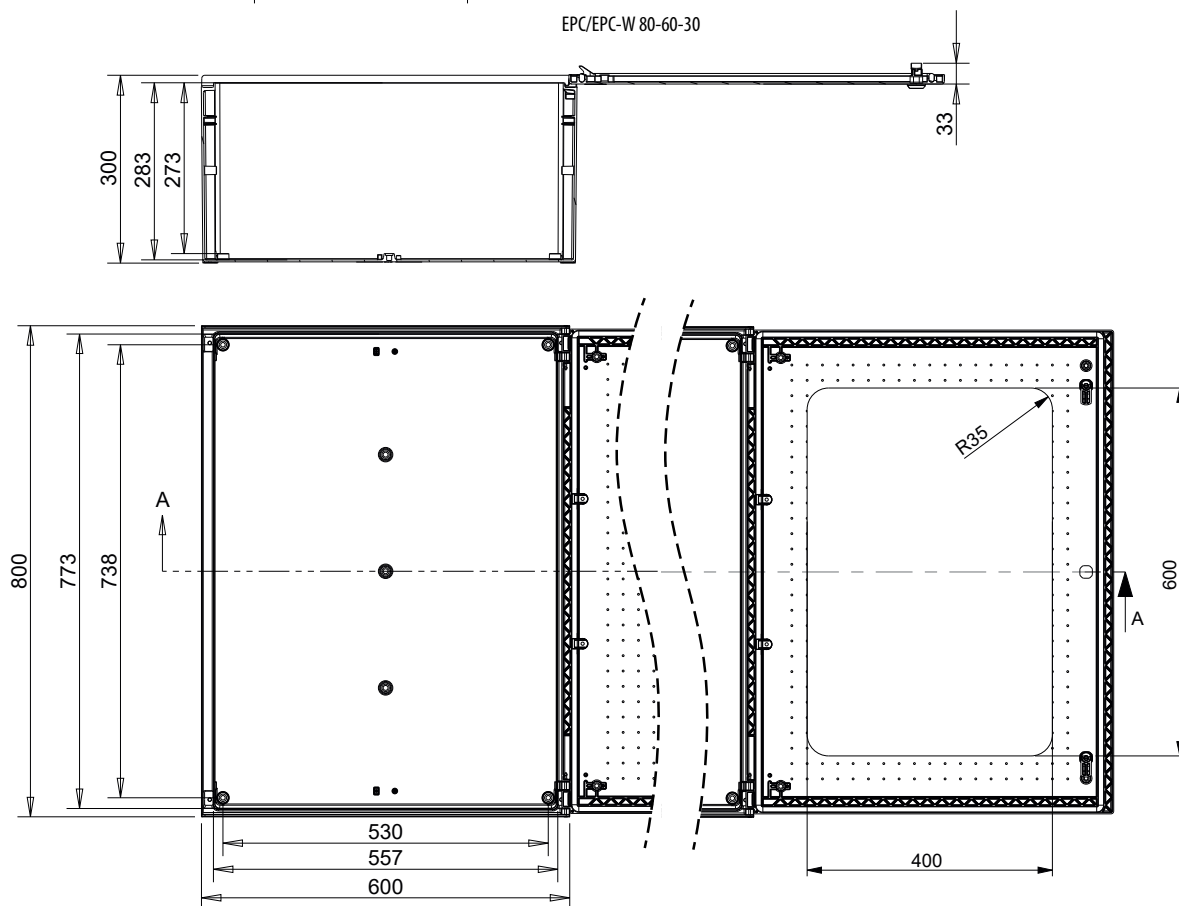

Accessories

Mounting plate EPC-PMP (polyester)

Type	Code No.	Description	Overall dimensions [mm]			Weight [g]	Packaging [pcs]
			Height	Width	Thickness		
EPC-PMP 30-25	001102616	Polyester plate	262	198	3	380	1
EPC-PMP 40-30	001102617	Polyester plate	360	248	3	590	1
EPC-PMP 40-40	001102618	Polyester plate	360	348	3	870	1
EPC-PMP 50-40	001102619	Polyester plate	460	348	3	1090	1
EPC-PMP 60-40	001102620	Polyester plate	558	348	3	1300	1
EPC-PMP 60-50	001102621	Polyester plate	558	448	3	1750	1
EPC-PMP 80-30	001102622	Polyester plate	756	248	3	1460	1
EPC-PMP 80-60	001102623	Polyester plate	756	548	4	2780	1



Mounting plate EPC-MMP (metal)

Type	Code No.	Description	Overall dimensions [mm]			Weight [g]	Packaging [pcs]
			Height	Width	Thickness		
EPC-MMP 30-25	001102624	Metal plate	262	198	2	790	1
EPC-MMP 40-30	001102625	Metal plate	360	248	2	1300	1
EPC-MMP 40-40	001102626	Metal plate	360	348	2	1900	1
EPC-MMP 50-40	001102627	Metal plate	460	348	2	2200	1
EPC-MMP 60-40	001102628	Metal plate	558	348	2	3000	1
EPC-MMP 60-50	001102629	Metal plate	558	448	2	3600	1
EPC-MMP 80-30	001102630	Metal plate	756	248	2	3260	1
EPC-MMP 80-60	001102631	Metal plate	756	548	2	6400	1



Accessories

Type	Code No.	Description	Overall dimensions [mm]			Weight [g]	Packaging [pcs]
			Height	Width	Depth		
EPC-DL10	001102632	Lock with universal key	50	20	20	40	1
EPC-LK	001102633	Lock with key	50	40	20	70	1
EPC-VDS	001102634	IP54 ventilation module (mini)	28	25	20	10	1
EPC-VDL	001102635	IP54 ventilation module (large)	68	50	23	30	1
EPC-WM	001102636	Wall mounting fixing lugs	67	28	25	90	1
EPC-DH-145	001102637	Door stop (145°)	6	1	1	10	1



EPC-DL10



EPC-LK



EPC-VDS



EPC-VDL



EPC-WM



EPC-DH-145

Polyester enclosures

Cable glands PG IP68

IP68 cable glands for cable entry in EPC enclosure, included nut and rubber.

Cable glands PG IP68

Type	Code No.	Thread	Cross-section		Overall dimensions [mm]				Weight [g]	Packaging [pcs]
			min.	max.	A	B	P1	P2		
PG-7	001102641	M-12	2,5	6,5	9	12,5	16	19	10	1
PG-9	001102642	M-16	4,5	8	9	15,5	19	22	10	1
PG-11	001102643	M-20	5	10	9	18,6	22	24	10	1
PG-13.5	001102644	M-20	6	12	10	20,4	24	26	20	1
PG-16	001102645	M-25	7	14	10	22,5	27	30	20	1
PG-21	001102646	M-32	11	18	12	28,3	33	36	20	1
PG-29	001102647	M-32	17	25	13	37	42	46	30	1
PG-36	001102648	M-40	22	32	16	47	52	56	30	1
PG-42	001102649	M-50	26	39	17	54	60	65	30	1
PG-48	001102650	M-63	30	44	18	59,3	64	70	40	1

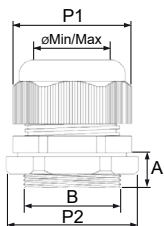

Connection flanges EPC-CF

For connecting 2 or more EPC enclosures (grouping).

Connection flanges EPC-CF

Type	Code No.	Description	Overall dimensions [mm]			Weight [g]	Packaging [pcs]
			Height	Width	Depth		
EPC-CF-A 23x10	001102638	Connection flange	230	100	20	150	1
EPC-CF-B 35x15	001102639	Connection flange	350	150	20	190	1
EPC-CF-C 35x15	001102640	Connection flange	350	150	20	240	1

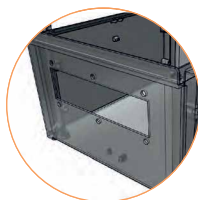
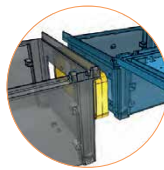
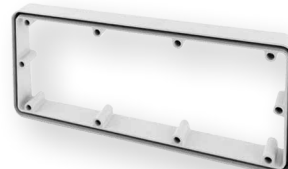

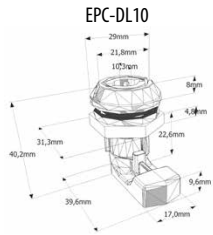

EPC-VDS (1)

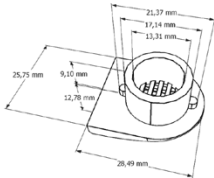

EPC-LK

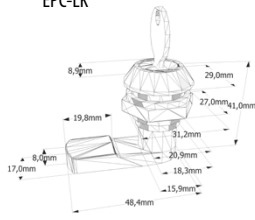

EPC-VDS (2)

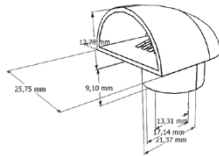

EPC-WM

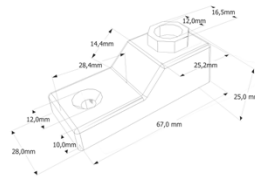

EPC-VDL

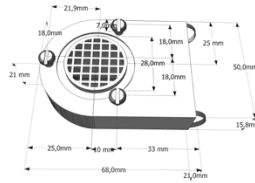

EPC-CF-A 23x10

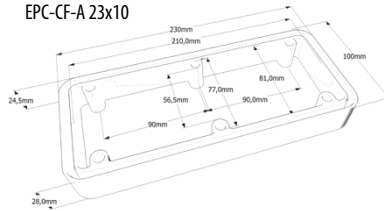

EPC-CF-B 35x15

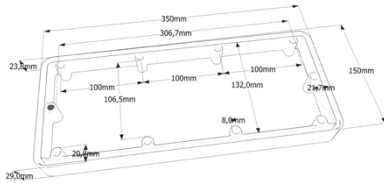

EPC-CF-C 35x15

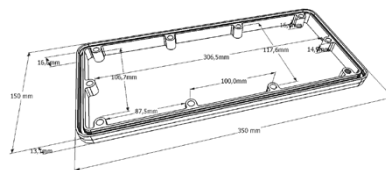

Possibilities to connect EPC-CF

(A) EPC-CF-A 23x10

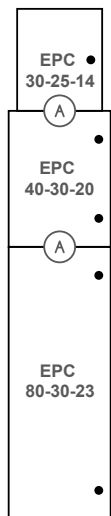

(B) EPC-CF-B 35x15

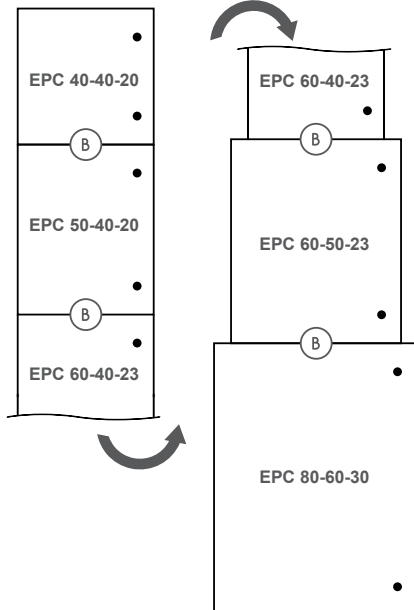

(C) EPC-CF-C 35x15

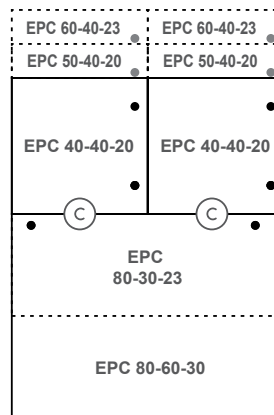

ETIBOX

Metal enclosures GT Type, IP66

Application :

GT-Type metal enclosures cover a wide range of applications both for industrial and civil buildings. Due to its design they provide high IP protection level, mechanical strength and functionality. They are used in places where electrical equipment is exposed to adverse effect of factors such as water, dust, mechanical impact..

Main advantages:

// Enclosures made of high quality sheet steel thicknesses from 1.2 mm to 2 mm, resistant to external mechanical factors - IK10.

// Specially profiled edges of the housing ensure stiffness and excellent protection against water. Poured polyurethane gasket on the door providing IP66 protection.

// Door opening in the contour of the outer casing, which allows direct linking of several enclosures in series - a special structure hinges. The door mounting on the left or right side.

Not for external use.

Compliance with standards and directives:

EN 62208 Empty enclosures for low voltage switchgear and controlgear

EN 60529 Degrees of protection provided by enclosures (IP Code)

EN 62262 Degrees of protection against external mechanical impacts provided by enclosures of electrical equipment (IK code)

Meet the requirements of the RoHS Directive

Marked CE

The enclosures are supplied with:

- Cable entry cover with mounting kit
- Mounting plate with mounting kit
- Door lock with, double-bit insert and key
 - Cover holes
- Earthing set of grounding (without cable)

Symbols:

GT 100-80-30

↑ ↑ ↑

Height Width Depth

Metal enclosures GT Type

Type	Code	Lock quantity	Hinges quantity	Weight [kg]	Packaging [pcs]
GT 25-20-15	001102100	1	2	3,61	1
GT 30-20-15	001102101	1	2	4,14	1
GT 30-30-15	001102102	1	2	5,65	1
GT 30-30-20	001102103	1	2	6,38	1
GT 30-30-25	001102104	1	2	7,13	1
GT 40-30-15	001102105	1	2	7,07	1
GT 40-30-20	001102106	1	2	7,90	1
GT 40-30-25	001102107	1	2	8,74	1
GT 40-40-15	001102108	1	2	8,92	1
GT 40-40-20	001102109	1	2	9,90	1
GT 40-40-25	001102110	1	2	10,89	1
GT 40-60-20	001102111	1	2	14,57	1
GT 40-60-25	001102112	1	2	15,87	1
GT 40-60-30	001102113	1	2	17,17	1
GT 50-40-15	001102114	2	2	10,69	1
GT 50-40-20	001102115	2	2	11,17	1
GT 50-40-25	001102116	2	2	12,86	1
GT 50-55-20	001102117	2	2	15,30	1
GT 50-55-25	001102118	2	2	16,62	1
GT 60-40-15	001102119	2	2	12,47	1
GT 60-40-20	001102120	2	2	13,64	1
GT 60-40-25	001102121	2	2	14,82	1
GT 60-60-20	001102122	2	2	20,02	1
GT 60-60-25	001102123	2	2	21,51	1
GT 60-60-30	001102124	2	2	22,99	1
GT 60-80-30	001102125	2	2	32,65	1
GT 65-55-20	001102126	2	2	19,86	1
GT 65-55-25	001102127	2	2	21,32	1
GT 80-40-20	001102128	2	3	19,45	1
GT 80-40-25	001102129	2	3	21,11	1
GT 80-55-20	001102130	2	3	26,17	1
GT 80-55-25	001102131	2	3	28,11	1
GT 80-60-20	001102132	2	3	28,13	1
GT 80-60-25	001102133	2	3	30,14	1
GT 80-60-30	001102134	2	3	32,17	1
GT 80-60-40	001102135	2	3	36,20	1
GT 80-80-20	001102136	2	3	35,93	1
GT 80-80-25	001102137	2	3	38,31	1
GT 80-80-30	001102138	2	3	40,68	1
GT 80-80-40	001102139	2	3	45,44	1
GT 80-100-30	001102140	2	3	49,20	1
GT 80-100-40	001102141	2	3	54,67	1



Metal enclosures GT Type

Type	Code	Lock quantity	Hinges quantity	Weight [kg]	Packaging [pcs]
GT 100-60-25	001102142	1*	3	36,35	1
GT 100-60-30	001102143	1*	3	38,60	1
GT 100-60-40	001102144	1*	3	43,10	1
GT 100-80-25	001102145	1*	3	46,11	1
GT 100-80-30	001102146	1*	3	48,72	1
GT 100-80-40	001102147	1*	3	53,94	1
GT 100-100-25	001102148	1*	3	55,87	1
GT 100-100-30	001102149	1*	3	58,83	1
GT 100-100-40	001102150	1*	3	64,78	1
GT 120-60-25	001102151	1*	3	42,55	1
GT 120-80-25	001102152	1*	3	53,90	1
GT 120-80-30	001102153	1*	3	56,76	1
GT 120-80-40	001102154	1*	3	62,45	1
GT 120-100-30	001102155	1*	3	68,47	1
GT 120-100-40	001102156	1*	3	74,88	1

*One lock with 3 point locking system (top, center, bottom)

Metal IP66 enclosures

Type	Height Y (mm)	Width X (mm)	Depth Z (mm)	Lock quantity	Hinges quantity	Cable entry depth B1 (mm)	Cable entry width A1 (mm)	Cover cable entry depth B (mm)	Cover cable entry width A (mm)
GT 25-20-15	250	200	150	1	2	70	140	110	180
GT 30-20-15	300	200	150	1	2	70	140	110	180
GT 30-30-15	300	300	150	1	2	70	240	110	280
GT 30-30-20	300	300	200	1	2	120	240	160	280
GT 30-30-25	300	300	250	1	2	170	240	210	280
GT 40-30-15	400	300	150	1	2	70	240	110	280
GT 40-30-20	400	300	200	1	2	120	240	160	280
GT 40-30-25	400	300	250	1	2	170	240	210	280
GT 40-40-15	400	400	150	1	2	70	340	110	380
GT 40-40-20	400	400	200	1	2	120	340	160	380
GT 40-40-25	400	400	250	1	2	170	340	210	380
GT 40-60-20	400	600	200	1	2	120	540	160	580
GT 40-60-25	400	600	250	1	2	170	540	210	580
GT 40-60-30	400	600	300	1	2	170	540	210	580
GT 50-40-15	500	400	150	2	2	70	340	110	380
GT 50-40-20	500	400	200	2	2	120	340	160	380
GT 50-40-25	500	400	250	2	2	170	340	210	380
GT 50-55-20	500	550	200	2	2	120	490	160	530
GT 50-55-25	500	550	250	2	2	170	490	210	530
GT 60-40-15	600	400	150	2	2	70	340	110	380
GT 60-40-20	600	400	200	2	2	120	340	160	380
GT 60-40-25	600	400	250	2	2	170	340	210	380
GT 60-60-20	600	600	200	2	2	120	540	160	580
GT 60-60-25	600	600	250	2	2	170	540	210	580
GT 60-60-30	600	600	300	2	2	170	540	210	580
GT 60-80-30	600	800	300	2	2	170	740	210	780
GT 65-55-20	650	550	200	2	2	120	490	160	530
GT 65-55-25	650	550	250	2	2	170	490	210	530
GT 80-40-20	800	400	200	2	3	120	340	160	380
GT 80-40-25	800	400	250	2	3	170	340	210	380
GT 80-55-20	800	550	200	2	3	120	490	160	530
GT 80-55-25	800	550	250	2	3	170	490	210	530
GT 80-60-20	800	600	200	2	3	120	540	160	580
GT 80-60-25	800	600	250	2	3	170	540	210	580
GT 80-60-30	800	600	300	2	3	170	540	210	580
GT 80-60-40	800	600	400	2	3	170	540	210	580
GT 80-80-20	800	800	200	2	3	120	740	160	780
GT 80-80-25	800	800	250	2	3	170	740	210	780
GT 80-80-30	800	800	300	2	3	170	740	210	780
GT 80-80-40	800	800	400	2	3	170	740	210	780
GT 80-100-30	800	1000	300	2	3	170	940	210	980
GT 80-100-40	800	1000	400	2	3	170	940	210	980
GT 100-60-25	1000	600	250	3p*	3	170	540	210	580
GT 100-60-30	1000	600	300	3p*	3	170	540	210	580
GT 100-60-40	1000	600	400	3p*	3	170	540	210	580
GT 100-80-25	1000	800	250	3p*	3	170	740	210	780
GT 100-80-30	1000	800	300	3p*	3	170	740	210	780
GT 100-80-40	1000	800	400	3p*	3	170	740	210	780
GT 100-100-25	1000	1000	250	3p*	3	170	940	210	980
GT 100-100-30	1000	1000	300	3p*	3	170	940	210	980
GT 100-100-40	1000	1000	400	3p*	3	170	940	210	980
GT 120-60-25	1200	600	250	3p*	3	170	540	210	580
GT 120-80-25	1200	800	250	3p*	3	170	740	210	780
GT 120-80-30	1200	800	300	3p*	3	170	740	210	780
GT 120-80-40	1200	800	400	3p*	3	170	740	210	780
GT 120-100-30	1200	1000	300	3p*	3	170	940	210	980
GT 120-100-40	1200	1000	400	3p*	3	170	940	210	980

*One lock with 3 point locking system (top, center, bottom)

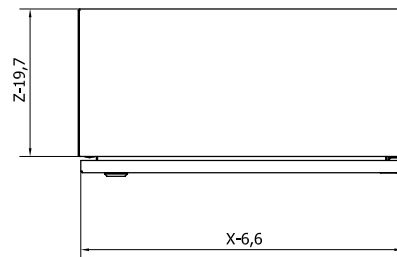
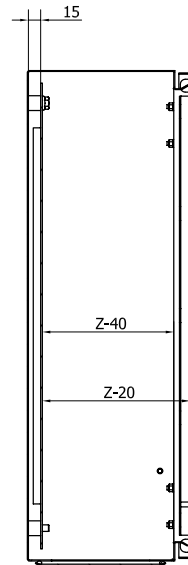
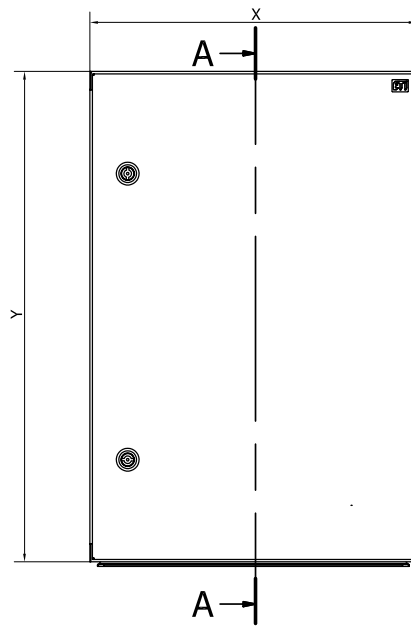
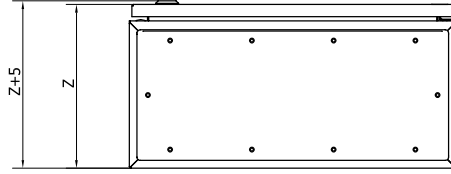
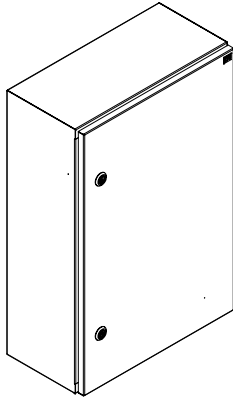

Metal IP66 enclosures

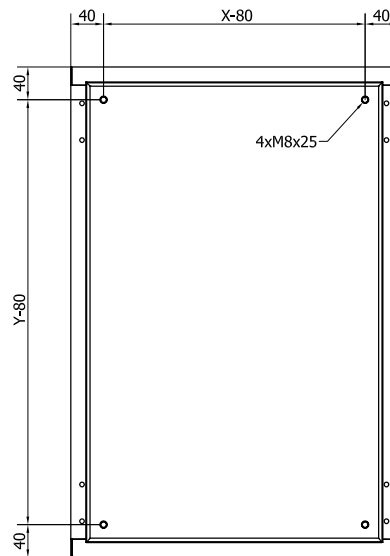
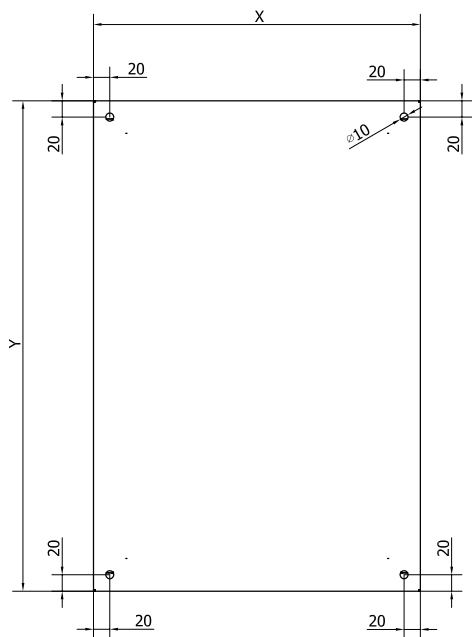

The door

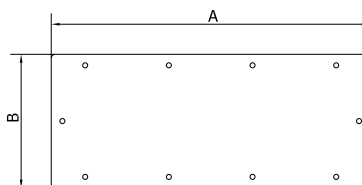
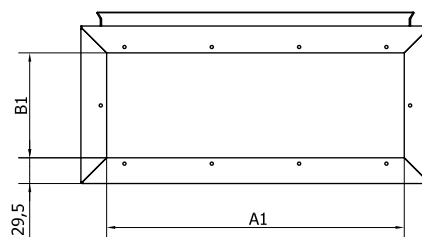
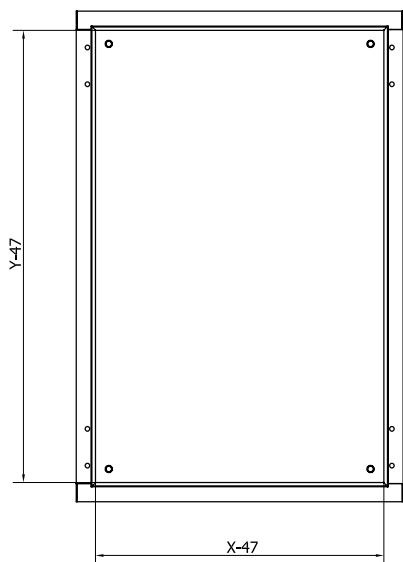

The cover of cable entry

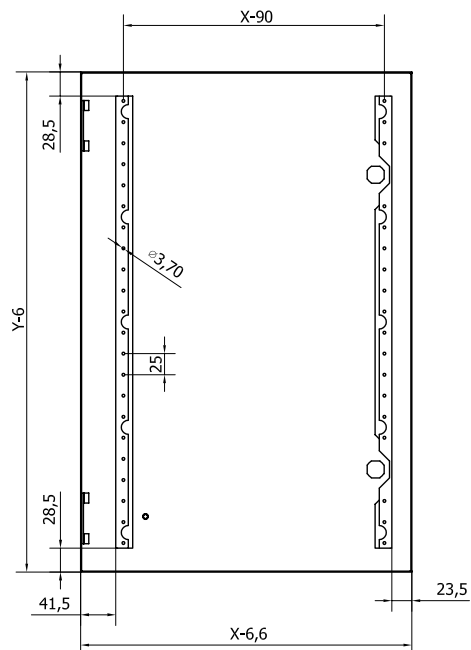
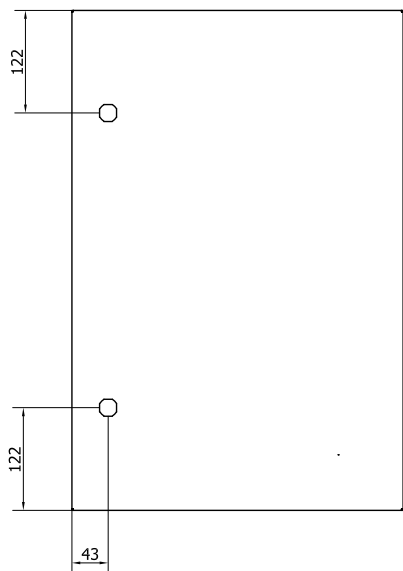

The door

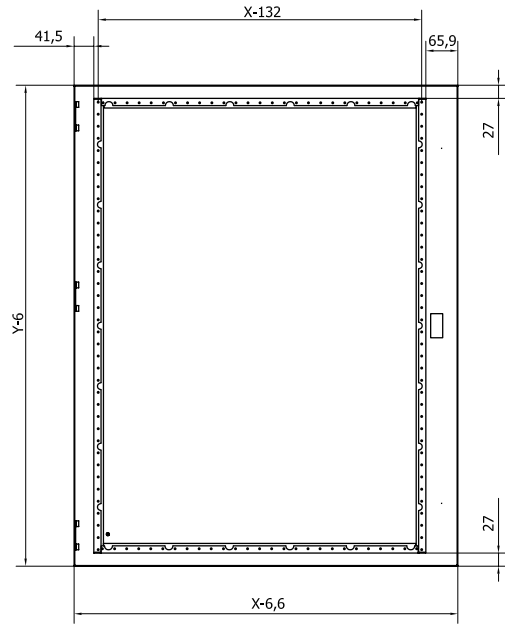
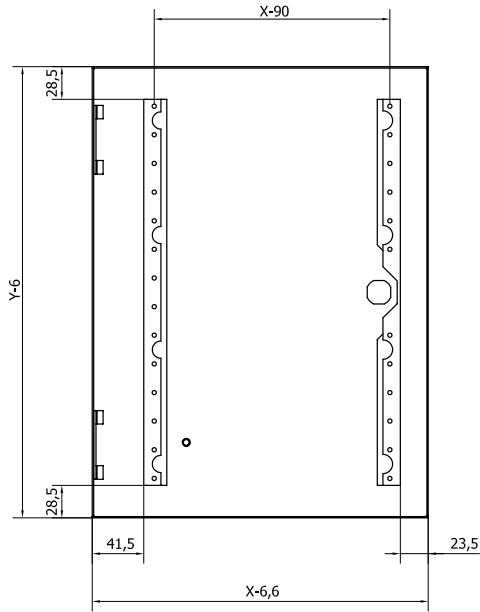

Wall holder

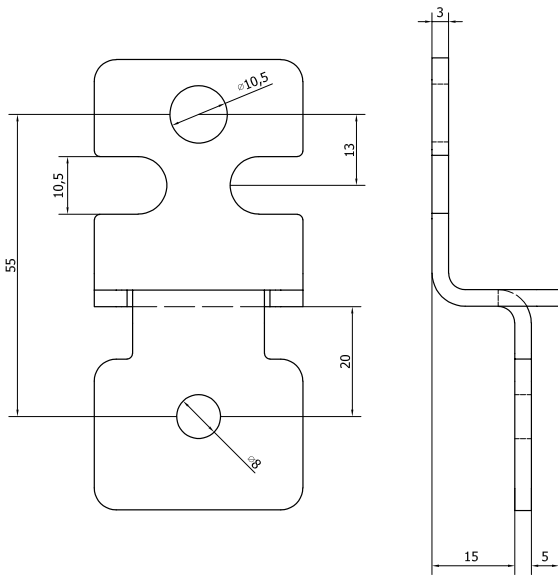

Mounting plate

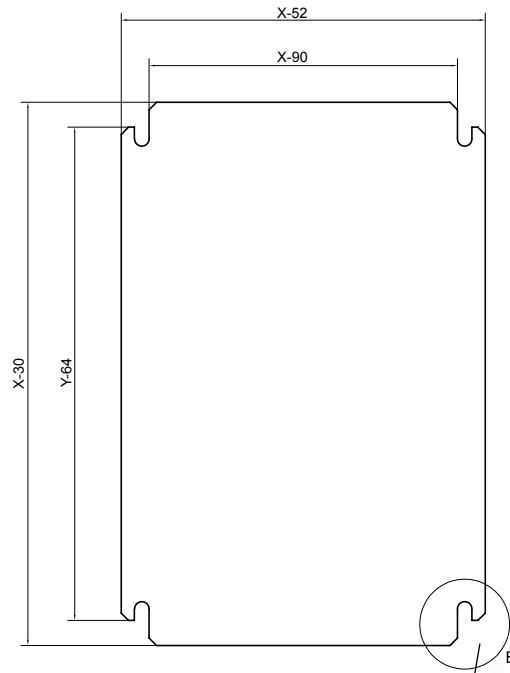

Door drilling

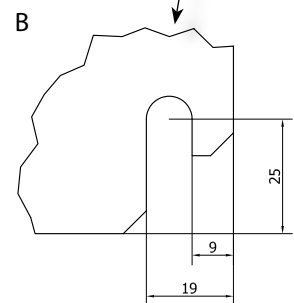
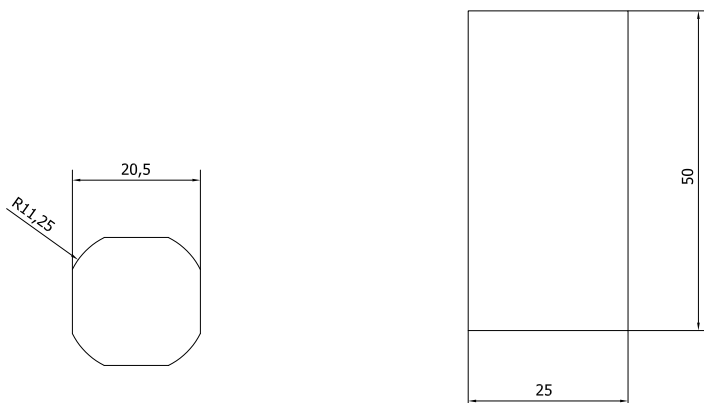

Accessories

Type	Code	Description	Weight [kg]	Packaging [pcs]
U400	001102166	Wall holders (set 4 pcs)	370	1
LK-D3-M22	001102167	Lock D3	70	1
LK-D5-M22	001102168	Lock D5	70	1
LK-KW8-M22	001102169	Lock DW	70	1
LK-T9-M22	001102170	Lock T9	70	1
LK-1333-M22	001102171	Patent lock 1333	90	1
LK-B1333-M22	001102172	Patent lock 1333 with knob	120	1
KEY-D5-M	001102173	Key D5 metal	40	1
KEY-T9-M	001102174	Key T9 metal	40	1
KEY-KW8-M	001102175	Key quadrat 8mm	40	1
KEY-UNI-M	001102176	Universal key	70	1
LPE-6	001102177	PE set 6mm ²	20	1
K-A4	001102178	Documentation A4 pocket	160	1



ETIBOX

Free-standing cable distribution cabinets

Free-standing cable distribution cabinets KVR

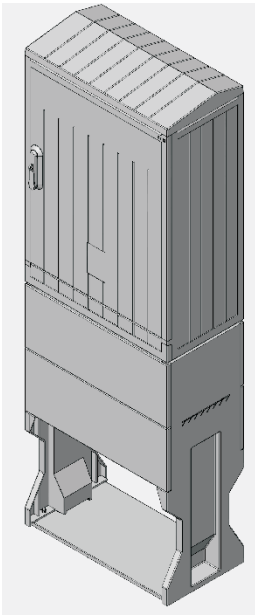

Electrical parameters

Rated operational voltage Un	400V
Rated insulation voltage Ui	690V
Flamability category	V0
Degree of protection against external mechanical impacts	IK 10
Protection degree	IP44
Protection class	II
Operating temperature	-25°C ... 40°C

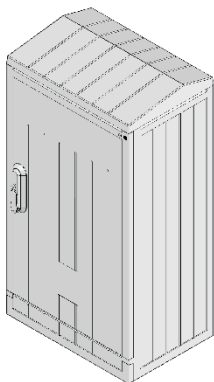

The KVR are DIN size stand-alone thermosetting enclosures with a depth of 320 mm comply with a range of requirements for electrical switchgear. They are made of thermosetting glass fibre reinforced polyester which has insulating, slow-burning and self-extinguishing properties and its typical features is high resistance to weather conditions (UV). These enclosures due to its multifunctional structure can be used in power electro distribution or telecom facilities as well as general public or industry purposes.

The module design allows to connect the enclosure with the pedestal or cable base. The external surface of these enclosures is ribbed which gives them additional strength and mechanical resilience and also prevents from covering with posters. Doors and segments can be dismantled by hands without any tools. The ventilation system used in the enclosures minimises accumulation of humidity.

- // Enclosures are made of glass fibre reinforced plastic (SMC)
- // Available frames sizes 00, 0, 1, 2
- // Depth 320 mm
- // Modular construction: enclosure, base, pedestal
- // Inclined roof
- // Three-point door closing with a revolving handle and the possibility of incorporating a half-cylinder insert
- // Three-point busbar holder adjustment
- // Standard protection class IP44
- // Material resistant to UV radiation, acids, strokes, atmospheric influences
- // Colour RAL 7035
- // Accessories
- // Standards: IEC 62208:2011, IEC 61439-5:2010

Enclosure - regular size (874mm)

Type	Code No.	Description	Weight [kg]	Packaging [pcs]
KVR 00	001601600	Single doors	14,20	1/1
KVR 0	001601601	Single doors	16,20	1/1
KVR 1	001601602	Two doors (split)	20,60	1/1
KVR 2	001601603	Two doors (split)	26,00	1/1

With possibility to use padlock

Enclosure - 1m size (1144mm)

Type	Code No.	Description	Weight [kg]	Packaging [pcs]
KVR 01	001601604	Single doors	21	1/1
KVR 11	001601605	Two doors (split)	26,5	1/1
KVR 21	001601606	Two doors (split)	33,5	1/1

With possibility to use padlock

Free-standing cable distribution cabinets

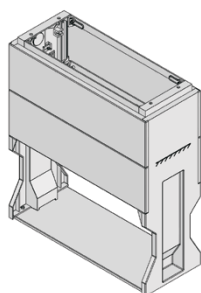

Pedestal

Type	Code No.	For use with	Weight [kg]	Packaging [pcs]
KVR-P 00	001601610	KVR 00	11,60	1
KVR-P 0	001601611	KVR 0, KVR 01	13,20	1
KVR-P 1	001601612	KVR 1, KVR 11	15,20	1
KVR-P 2	001601613	KVR 2, KVR 21	17,80	1

Pedestal extender

Type	Code No.	For use with	Weight [kg]	Packaging [pcs]
KVR-PE 00	001601620	KVR 00	4,60	1
KVR-PE 0	001601621	KVR 0, KVR 01	5,20	1
KVR-PE 1	001601622	KVR 1, KVR 11	6,00	1
KVR-PE 2	001601623	KVR 2, KVR 21	7,40	1

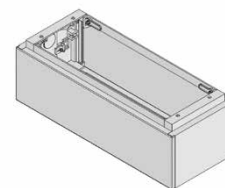

Mounting plate metal Zn for regular size (874mm) enclosure

Type	Code No.	For use with	Weight [kg]	Packaging [pcs]
KVR-MP 00	001601630	KVR 00	5,20	4
KVR-MP 0	001601631	KVR 0	6,80	4
KVR-MP 1	001601632	KVR 1	9,20	4
KVR-MP 2	001601633	KVR 2	13,00	4

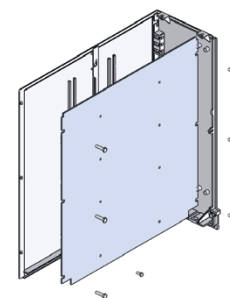

Mounting plate metal Zn for 1m size enclosure

Type	Code No.	For use with	Weight [kg]	Packaging [pcs]
KVR-MP 01	001601634	KVR 01	6,3	4
KVR-MP 11	001601635	KVR 11	8,75	4
KVR-MP 21	001601636	KVR 21	17	4
KVR-MP 2	001601633	KVR 2	13,00	4

Copper bars without pressed nuts - available upon request

Type	Dimension, for use with	Weight [kg]	Packaging [pcs]
KVR-CB 00 30x5	30x5x444, KVR 00	0,60	4
KVR-CB 00 40x5	40x5x444, KVR 00	0,78	4
KVR-CB 0 30x5	30x5x580, KVR 0, KVR 01	0,78	4
KVR-CB 0 40x5	40x5x580, KVR 0, KVR 01	1,05	4
KVR-CB 1 40x5	40x5x774, KVR 1, KVR 11	1,35	4
KVR-CB 1 40x10	40x10x774, KVR 1, KVR 11	2,70	4
KVR-CB 1 60x10	60x10x774, KVR 1, KVR 11	4,10	4
KVR-CB 2 40x5	40x5x1104, KVR 2, KVR 21	1,90	4
KVR-CB 2 40x10	40x10x1104, KVR 2, KVR 21	3,80	4
KVR-CB 2 60x10	60x10x1104, KVR 2, KVR 21	5,80	4

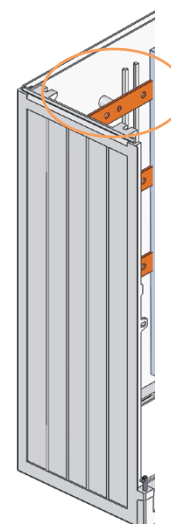

Angle bar for cable fixation

Type	Code No.	Dimension, for use with	Weight [kg]	Packaging [pcs]
KVR-FB 00	001601640	450mm, KVR 00	0,42	4
KVR-FB 0	001601641	585mm, KVR 0, KVR 01	0,58	4
KVR-FB 1	001601642	784mm, KVR 1, KVR 11	0,76	4
KVR-FB 2	001601643	1110mm, KVR 2, KVR 21	1,00	4

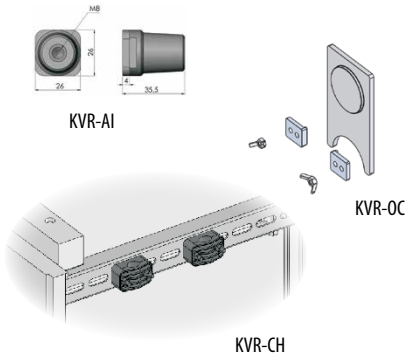
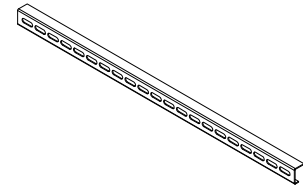

Common accessories

Type	Code No.	Description	Weight [kg]	Packaging [pcs]
KVR-AI	001601650	Support insulator	0,025	20
KVR-OC	001601651	Cable culvert	0,35	10
KVR-CH 120	001601652	Cable holder	0,14	10
KVR-CH 240	001601653	Cable holder	0,20	10

Examples of use for KVR-AI and KVR-OC on page 866

Dimensions

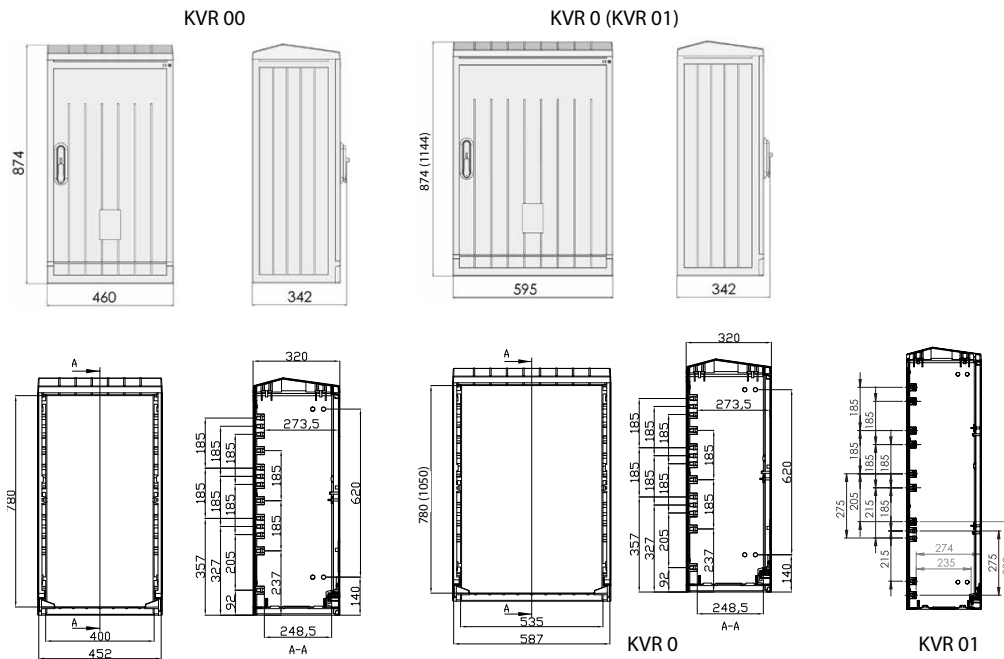

Free-standing cable distribution cabinets

KVR 1 (KVR 11)

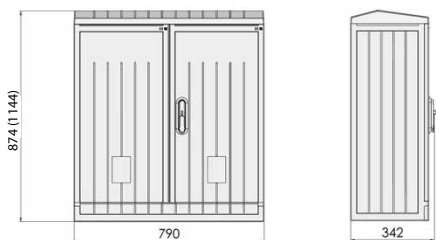

KVR 2 (KVR 21)

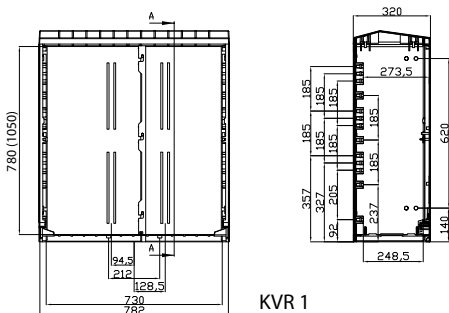
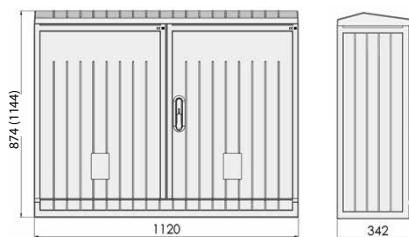

KVR 1

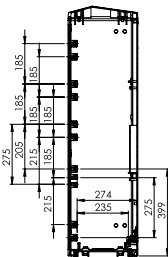

KVR 11

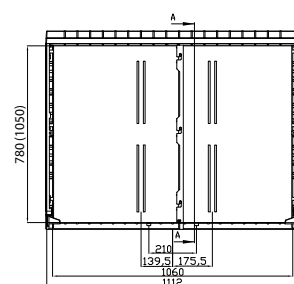

KVR 2

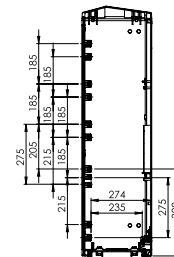

KVR 21

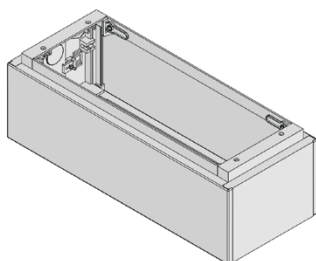
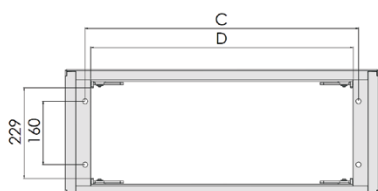
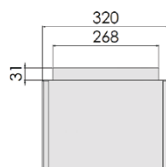
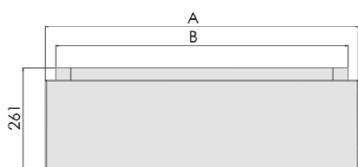
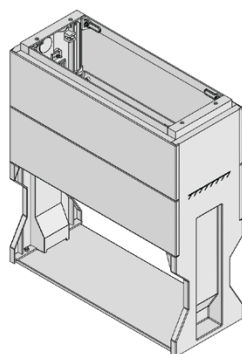
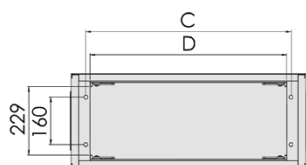
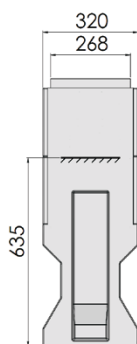
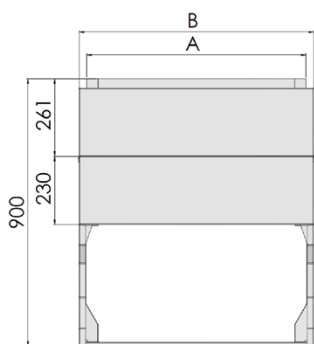

[mm]	A	B	C	D
KVR-P 00	408	460	360	332
KVR-P 0	543	595	495	467
KVR-P 1	738	790	690	662
KVR-P 2	1068	1120	1020	992

[mm]	A	B	C	D
KVR-PE 00	460	408	360	332
KVR-PE 0	595	543	495	467
KVR-PE 1	790	738	690	662
KVR-PE 2	1120	1068	1020	992

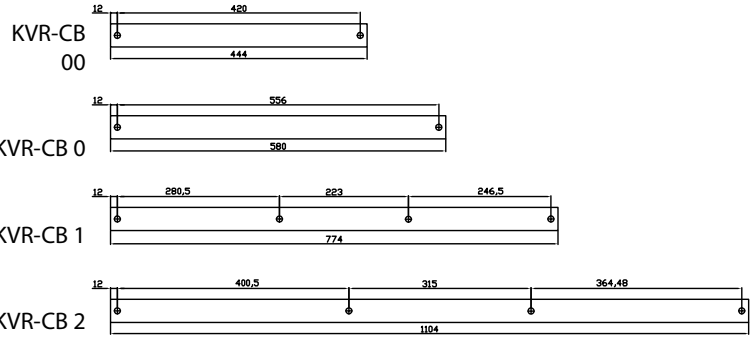
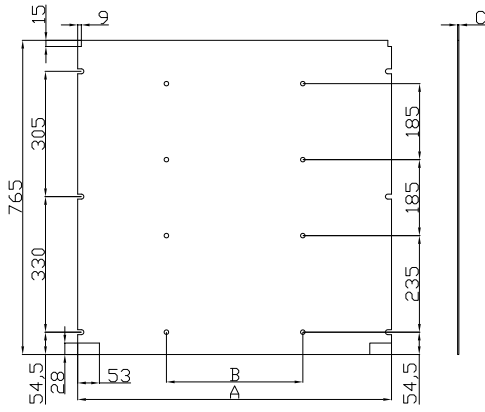

[mm]	A	B	C
KVR-MP 00	435	-	2
KVR-MP 0	572	-	2
KVR-MP 1	764	300	2
KVR-MP 2	1095	400	2

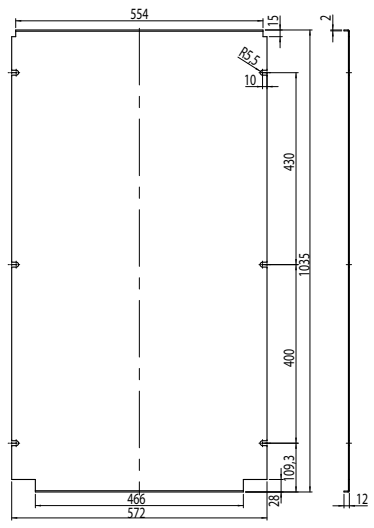

MP01

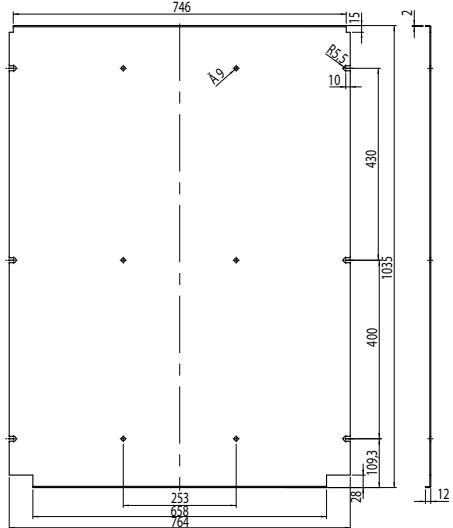

MP11

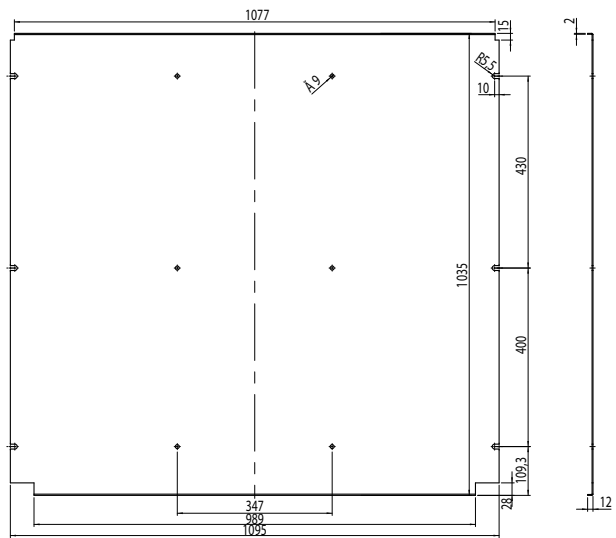

MP21

Free-standing cable distribution cabinets

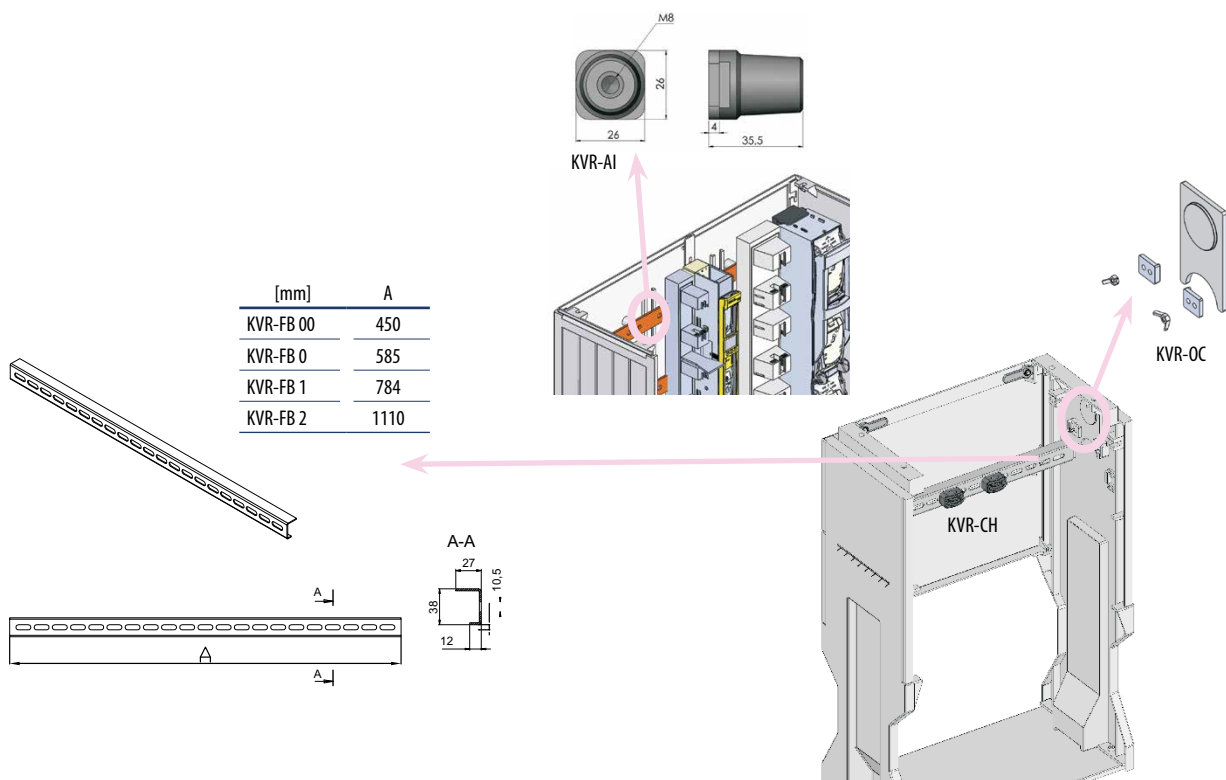

Enclosure ventilation

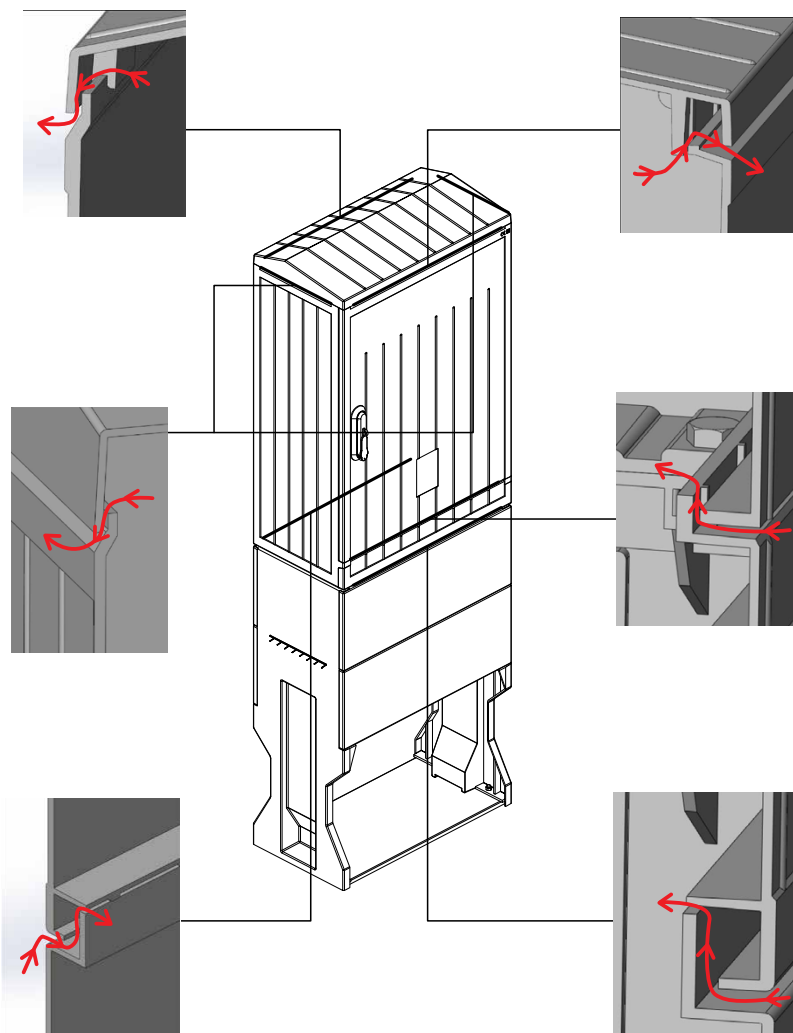

ETIBOX Accessories

Phase busbars

Terminal for protective conductors			
type	length	supply	outlet
	[m]	[mm ²]	[mm ²]
2/6	0,056	2 x 22	6 x 14
2/8	0,086	2 x 22	8 x 14
2/12	0,092	2 x 22	12 x 14
2/18	0,128	2 x 22	18 x 14

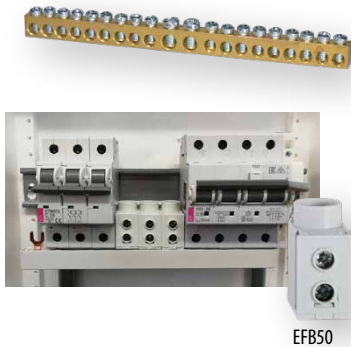
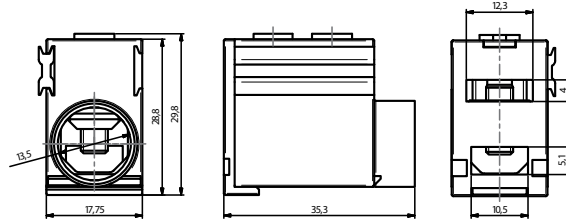

EFB50

Terminal for protective conductor

Type	Code No.	Dimensions [mm]	Weight [g]	Packaging [pcs]
2/6	002911101	6x9x56	23,3	100
2/8	002911102	6x9x86	28,5	100
2/12	002911103	6x9x92	39,3	100
2/18	002911104	6x9x128	53,8	100
EFB50*	002921278	50	29	10

*To connect cable up to 50mm² on Cu busbar(phase busbars) fork or pin type

Fork type

Technical data - Section rails for ETIMAT P10

Cross section	10 mm ²	16 mm ²	25 mm ²
Feeding at beginning/ending			
Max. current I _s /Phase	63	80	100
Cross section of connection, mm ²	10	16	25
Feeding in the middle			
Max. current I _e /Phase	100	130	170
Cross section of connection, mm ²	25	35	2x25
Heat deflection temperature PVC	80°C flame resistant		
Comparative tracking index PVC	300V		
Standards	EN 60947-1:2007/ IEC 60947-1:2007		
Climate stability	DIN EN 60068		
Insulation coordination	Degree of pollution 2		
Electrical data			
Impulse voltage strength	≥4,5 kV		
Min. air distance	> 5,5 mm		
Min. creeping distance	> 5 mm		
Max. operating voltage	690 V AC/DC		
Protection class	IP20		
Short circuit rating	ICC 15kA NH 250A gL 500V		
Dielectric strength	≥ 32 kV/mm		
Material			
	Material	Surface	
Busbar	Copper	plain	
Insulation	PVC lead-free	grey RAL 7035	
Endcover	moulded		

Ampacity at 35 °C ambient temperature depending of feeding point

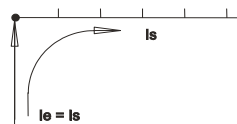

Feeding at beginning / ending

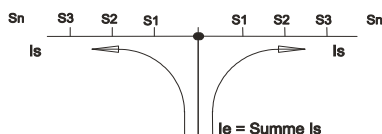

Feeding in the middle

In case of center-feeding, please note that the sum of junction currents S1...Sn per rail branch may not be bigger than the above named max. currents I_s/Phase.

Phase busbars 16mm² 80A(side connection)/130A (middle connection), fork type

Type	Additional description	Code No.	Length [mm]	Weight [g]	Packaging [pcs]	For use with
Iz16/2F/56 18mm	2 pole terminal, 56 module width	002921230	1012	525	10	ETIMAT P10 1P+N, 2P
Iz16/3F/57 18mm	3 pole terminal, 57 module width	002921231	1027	840	10	ETIMAT P10 3P
Iz16/4F/56 18mm	4 pole terminal, 56 module width	002921232	1010	1205	10	ETIMAT P10 3P+N

Phase busbars 16mm² 80A(side connection)/130A (middle connection), fork type

Type	Additional description	Code No.	Length [mm]	Weight [g]	Packaging [pcs]	For use with
Iz16/2F/44 18+9mm	2 pole terminal with extra space	002921233	990	525	10	ETIMAT 2P, DC + aux. contact

Phase busbars 10mm² for AFDD

Type	Additional description	Code No.	Cross section [mm ²]	Length [m]	Weight [g]	Packaging [pcs]	For use with
Iz10/2F/19	10mm ² , 2 p, 19 KZS AFDDs	002921294	10	1,012	0,378	10	KZS AFDD
Iz10/4F/18	10mm ² , 4 p, 18 KZS AFDDs	002921295	10	0,965	0,589	10	KZS AFDD

End covers

Type	Code No.	Weight [g]	Packaging [pcs]	For use with
Z-16/2F/3F 18mm	002921240	3	50	Iz16/2F/56 18mm (002921230), Iz16/3F/57 18mm (002921231), Iz16/2F/44 27mm (002921232), Iz10/2F/19 (002921294)
Z-16/4F 18mm	002921241	2	50	Iz16/4F/56 18mm (002921232), Iz10/L1NL2NL3N (002921279), Iz10/4F/18 (002921295)

Phase busbars 10 mm² 63A

Type	Additional description	Code No.	Cross section [mm ²]	Length [m]	Weight [g]	Packaging [pcs]	For use with
IZ10/1F/54*	10mm ² , 1-phase, 54 mod.	002921142	10	1,00	260	40	ETIMAT6, ETIMAT P10, ETITEC,SV, VLD01
IZ10/3F/12	10mm ² , 3-phase, 12 mod.	002921140	10	0,21	115	20/240	
IZ10/3F/54*	10mm ² , 3-phase, 54 mod.	002921141	10	1,00	560	20	
IZ10/1F/12	10mm ² , 1-phase, 12 mod.	002921143	10	0,21	50	40/240	
IZ10/L1NL-2NL3N/12	10mm ² , 4-pole, 12 mod.	002921268	10	0,21	228	10	ETIMAT6 1P+N, ETIMAT P10 1P+N, KZS-2M
IZ10/L1NL2NL3N/54	10mm ² , 4-pole, 1m / 53 mod.	002921279	10	0,965	536	10	ETIMAT6 1P+N, ETIMAT P10 1P+N, KZS-2M
IZ10/L1L2L3NL-1NL2NL3N	10mm ² , 4-pole, 12 mod.	002921275	10	0,21	131	10	EF14 + ETIMAT 6 1P+N, ETIMAT P10 1P+N
IZ10/L1L2L3NL1/NL2/NL3/N	10mm ² , 4-pole, 12 mod.	002921276	10	0,21	255	50	EF14+ETIMAT1N, KZS1M
IZ10/L1L2L3_L1L2L3	10mm ² , 3-pole, 12 mod.	002921277	10	0,21	120	10	EF14 + ETIMAT 6, ETIMAT P10

*Not for ETIMAT P10 MULTIPOLE (2P, 3P, 1P+N, 3P+N) with length more than 12 modules.



Phase busbars 12 mm² 80A

Type	Additional description	Code No.	Cross section [mm ²]	Length [m]	Weight [g]	Packaging [pcs]	For use with
IZ12/1F/12	12mm ² , 1-phase, 12 modul	002921018	12	0,21	57	40/480	ETIMAT6, ETIMAT P10, ETITEC,SV, VLD01
IZ12/1F/54*	12mm ² , 1-phase, 54 mod.	002921026	12	1,00	260	40	
IZ12/3F/9	12mm ² , 3-phase, 9 mod.	002921017	12	0,16	81	20/240	
IZ12/3F/12	12mm ² , 3-phase, 12 mod.	002921020	12	0,21	115	20/240	
IZ12/3F/18*	12mm ² , 3-phase, 18 mod.	002921022	12	0,32	180	20/120	
IZ12/3F/54*	12mm ² , 3-phase, 54 mod.	002921024	12	1,00	560	20	

*Not for ETIMAT P10 MULTIPOLE (2P, 3P, 1P+N, 3P+N) with length more than 12 modules.



Phase busbars 16 mm² (normal) 100A

Type	Additional description	Code No.	Cross section [mm ²]	Length [m]	Weight [g]	Packaging [pcs]	For use with
IZ16/1F/12P	16mm ² , 1-phase, 12 modul	002921091	16	0,21	70	40/360	ETIMAT6, ETIMAT P10, ETITEC,SV, VLD01
IZ16/1F/54P*	16mm ² , 1-phase, 54 mod.	002921092	16	1,00	320	40	
IZ16/3F/12	16mm ² , 3-phase, 12 mod.	002921061	16	0,21	155	20/180	
IZ16/3F/54*	16mm ² , 3-phase, 54 mod.	002921063	16	1,00	700	20	

*Not for ETIMAT P10 MULTIPOLE (2P, 3P, 1P+N, 3P+N) with length more than 12 modules.

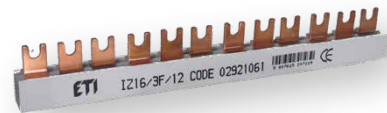

Phase busbars 16mm² (2 pole and 4 pole) 100A

Type	Additional description	Code no.	Cross section (mm ²)	Length (m)	Weight (g)	Packaging (pcs)	For use with
IZ16/2F/12	16mm ² , 2-pole, 12 mod.	002921066	16	0,21	120	10/120	EF1-2, EF1-4, KZS-2M, KZS-4M
IZ16/2F/54*	16mm ² , 2-pole, 54 mod.	002921067	16	1	550	10	
IZ16/4F/12	16mm ² , 4-pole, 12 mod.	002921068	16	0,21	230	10/80	ETIMAT6, P10, SV, ETITEC, VLD01
IZ16/4F/56*	16mm ² , 4-pole, 56 mod.	002921070	16	1	1020	10	

*Not for ETIMAT P10 MULTIPOLE (2P, 3P, 1P+N, 3P+N) with length more than 12 modules.

Phase busbars 16 mm² (L shape) 100A

Type	Additional description	Code No.	Cross section [mm ²]	Length [m]	Weight [g]	Packaging [pcs]	For use with
IZ16/1F/2/L	16mm ² , 1-phase, 2 modul	002921081	16	0,03	11	50/600	ETIMAT6, ETIMAT P10, ETITEC,SV, VLD01
IZ16/1F/3/L	16mm ² , 1-phase, 3 mod.	002921082	16	0,05	16	50/600	
IZ16/1F/4/L	16mm ² , 1-phase, 4 mod.	002921083	16	0,07	21	50/600	
IZ16/1F/12/L	16mm ² , 1-phase, 12 mod.	002921060	16	0,21	65	40/360	
IZ16/1F/54/L*	16mm ² , 1-phase, 54 mod.	002921062	16	1,00	290	40	

*Not for ETIMAT P10 MULTIPOLE (2P, 3P, 1P+N, 3P+N) with length more than 12 modules.





Phase busbars 16 mm² (STV) 100A

Type	Additional description	Code No.	Cross section [mm ²]	Length [m]	Weight [g]	Packaging [pcs]	For use with
Iz16/1F/12/STV	16mm ² , 1-phase, 12 mod.	002921071	16	0,32	95	40/240	STVD02
Iz16/1F/36/STV	16mm ² , 1-phase, 36 mod.	002921073	16	1,00	280	40	
Iz16/3F/12/STV	16mm ² , 3-phase, 12 mod.	002921072	16	0,32	230	20/120	
Iz16/3F/36/STV	16mm ² , 3-phase, 36 mod.	002921074	16	1,00	700	20	

Phase busbars for Motor switches - IZM (16 mm²) 100A

Type	Additional description	Code No.	Cross section [mm ²]	Length [m]	Weight [g]	Packaging [pcs]	For use with
IzM16/3F/4	16mm ² , 3-phase, 12 mod.	002921132	10	0,20	155	20	MPE 25 (no side accessories)
IzM16/3F/20	16mm ² , 3-phase, 54 mod.	002921133	10	1,00	700	20	

Busbars for motor protective circuit breakers - MPCB: MPE25, MSP0, MS25, 10mm² 63 A/690 VAC

Type	Additional description	Code No.	Cross section [mm ²]	Length [m]	Weight [g]	Packaging [pcs]	For use with
IzM-L3-25	Feed-in terminal, 3 pole, 6-25mm ²	002921297	10	44	40	10	MPE25, MSP0, MS25
IzM45-2	3-phase, 45 mm, 14 mm pitch	002921298	10	86,5	35	10	2 x MPCB
IzM45-3	3-phase, 45 mm, 14 mm pitch	002921299	10	131,5	57	10	3 x MPCB
IzM45-4	3-phase, 45 mm, 14 mm pitch	002921300	10	176,5	80	10	4 x MPCB
IzM45-5	3-phase, 45 mm, 14 mm pitch	002921301	10	221,5	100	10	5 x MPCB
IzM54-2	3-phase, 54 mm, 14 mm pitch	002921302	10	95,5	38	10	2 x (MPCB + auxiliary contact)
IzM54-3	3-phase, 54 mm, 14 mm pitch	002921303	10	149,5	61	10	3 x (MPCB + auxiliary contact)
IzM54-4	3-phase, 54 mm, 14 mm pitch	002921304	10	203,5	88	10	4 x (MPCB + auxiliary contact)
IzM54-5	3-phase, 54 mm, 14 mm pitch	002921305	10	257,5	109	10	5 x (MPCB + auxiliary contact)
IzM63-2	3-phase, Fork, 53 mm, 14 mm pitch	002921307	10	104,5	41	10	2 x MPS+ 2x Auxiliary switch or 1x release
IzM63-3	3-phase, Fork, 53 mm, 14 mm pitch	002921308	10	167,5	69	10	3 x MPS+ 2x Auxiliary switch or 1x release
IzM63-4	3-phase, Fork, 53 mm, 14 mm pitch	002921309	10	230,5	97	10	4 x MPS+ 2x Auxiliary switch or 1x release
IzM63-5	3-phase, Fork, 53 mm, 14 mm pitch	002921310	10	293,5	125	10	5 x MPS+ 2x Auxiliary switch or 1x release

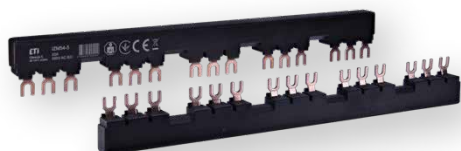



ATTENTION: To prevent electrical shock, disconnect from power source before installing or servicing.

1.

Cut

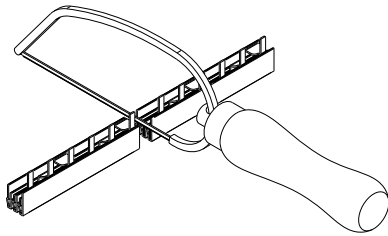

Danger Installation by electricians only

2.

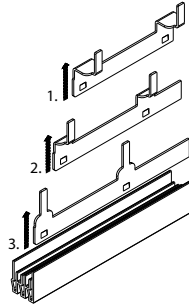

3.



Due to security purposes all shortened busbars need to be covered with suitable endcovers.

Cut back copper

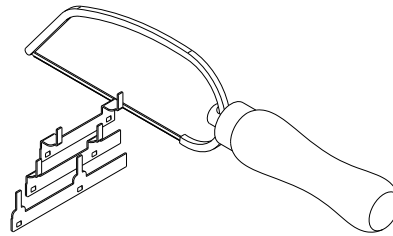

4.

Burr

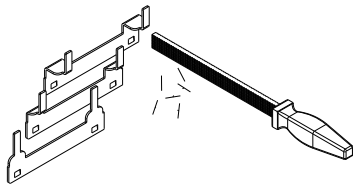

5.

Clean

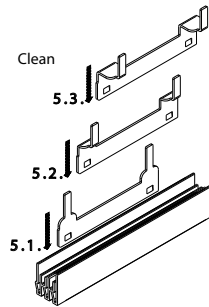

6.

Attach end cover

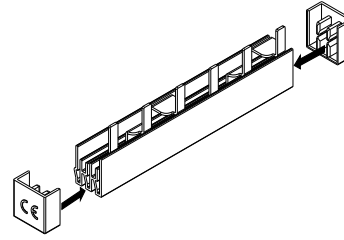

Selection of wiring harness depending on the equipment type

Type of equipment	Wiring diagram	Type	No. of modules	Length [m]	Fork (FORK type)		
					10mm ² (63A)	12mm ² (80A)	16mm ² (100A)
MCBs and modular devices (17,8 mm wide): - ST-68 (6-63A), - ETIMAT 6 (0,5-63A), - ETIMAT 10 (0,5-63A), - SV (16-125).		1P	2	0,03			002921081 IZ16/1F/2L
			3	0,05			002921082 IZ16/1F/3L
			4	0,07			002921083 IZ16/1F/4L (angle)
		12	0,21	002921143 IZ10/1F/12	002921018 IZ12/1F/12	002921091 IZ16/1F/12	
		54	1,00	002921142 IZ10/1F/54	002921026 IZ12/1F/54	002921060 IZ16/1F/12L 002921092 IZ16/1F/54 002921062 IZ16/1F/54L	
		1P+N	12	0,21			002921066 IZ16/2F/12
			54	1,00			002921067 IZ16/2F/54
		3P+N	12	0,21	002921268, 002921212 IZ10/L1NL2NL3N/12 (E)		002921215 IZ16/L1NL2NL3N/12
			18	0,32	002921213 IZ10/L1NL2NL3N/18		002921216 IZ16/L1NL2NL3N/18
			54	1,00	002921279, 002921214 IZ10/L1NL2NL3N/54 (E)		002921217 IZ16/L1NL2NL3N/54
		3P	9	1,00		002921017 IZ12/3F/9	
			12	0,21	002921140 IZ10/3F/12	002921020 IZ12/3F/12	002921061 IZ16/3F/12
			18	0,32		002921022 IZ12/3F/18	
			54	1,00	002921141 IZ10/3F/54	002921024 IZ12/3F/54	002921063 IZ16/3F/54
		3P+N	12	0,21			002921068 IZ16/4F/12
56			1,00			002921070 IZ16/4F/54	
Type of equipment	Wiring diagram	Type	No. of modules	Length [m]	10mm ² (63A)	Pin (PIN type)	16mm ² (100A)
MCBs and modular devices (17,8 mm wide): - ST-68 (6-63A), - ETIMAT 6 (0,5-63A), - ETIMAT 10 (0,5-63A), - SV (16-125).		1P	12	0,21	002921100 IZS10/1F/12		002921110 IZS16/1F/12
			54	1,00	002921101 IZS10/1F/54		002921111 IZS16/1F/54
		3P	12	0,21	002921102 IZS10/3F/12		002921112 IZS16/3F/12
			18	0,32			002921113 IZS16/3F/18
			54	1,00	002921103 IZS10/3F/54		002921114 IZS16/3F/54
Type of equipment	Wiring diagram	Type	No. of modules	Length [m]	25mm ² (100A)	Pin (PIN type)	35mm ² (125A)
MCBs and modular devices (17,8 mm wide): - ST-68 (6-63A), - ETIMAT 6 (0,5-63A), - ETIMAT 10 (0,5-63A), - ETIMAT 10 DC (0,5-63A), - SV (16-125).		1P	57	1,01	002921290 IZS25/1F/57 (angle 600V AC/1000V DC)		002921291 IZS35/1F/57 (angle 600V AC/1500V DC)
Type of equipment	Wiring diagram	Type	No. of modules	Length [m]	16mm ² (80A/130A)	Pin (PIN type)	50mm ² (160A/250A)
MCBs (27 mm wide): - ETIMAT 10 (80-125A).		1P	37	0,98	002921250 IZ16/1F/37 (angle)		002921251 IZ50/1F/37 (angle)
			39	1,05	002921254 IZ16/3F/39		002921255 IZ50/3F/39
	3P	39	1,05	002921254 IZ16/3F/39		002921255 IZ50/3F/39	
Type of equipment	Wiring diagram	Type	No. of modules	Length [m]	10mm ² (63A)	Fork (FORK type)	16mm ² (100A)
RCCBs (17,8 mm wide): - EFI-P2, - EFI-P4. RCBOs (17,8 mm wide): - KZS-2M, - KZS-4M.		1P+N	12	0,21			002921066 IZ16/2F/12
			54	1,00			002921067 IZ16/2F/54
		1P+N	12	0,21	002921268, 002921212 IZ10/L1NL2NL3N/12 (E)		002921215 IZ16/L1NL2NL3N/12
			18	0,32	002921213 IZ10/L1NL2NL3N/18		002921216 IZ16/L1NL2NL3N/18
			54	1,00	002921279, 002921214 IZ10/L1NL2NL3N/54 (E)		002921217 IZ16/L1NL2NL3N/54
		3P+N	12	0,21			002921068 IZ16/4F/12
56			1,00			002921070 IZ16/4F/54	
Type of equipment	Wiring diagram	Type	No. of modules	Length [m]	Fork (FORK type)	10mm ² (63A)	
Combination EFI-P4 - 1 pc + ETIMAT 6 1P+N-4 pcs (or KZS-2M- 4 pcs).		3P+N	12	0,21		002921275 IZ10/L1L2L3N-L1NL2NL3N	
Combination EFI-P4 - 1 pc + KZS-1M - 8 pcs (bottom connection).		3P+N	12	0,21		002921276 IZ10/L1L2L3N-L1/NL2/NL3/N	
Combination EFI-P4 - 1 pc + ETIMAT 6, 10 1P - 8 pcs.		3P+N	12	0,21		002921277 IZ10/L1L2L3_L1L2L3	

Type of equipment	Wiring diagram	Type	No. of modules	Length [m]	Pin (PIN type)	
					10mm ² (63A)	16mm ² (100A)
RCBOs (17,8 mm wide): - KZS-1M SUP (top connection).		1P+N	12	0,22	002921148 SKN0022/10 (1p+N)	
		3P+N	12	0,22	002921149 SKN0030/10 (3p+N)	
RCBOs (17,8 mm wide): - KZS-1M (bottom connection).		1P+N	12	0,22	002921150 SKN0021/10 (1p+N)	
		3P+N	12	0,22	002921154 SKN0029/10 (3p+N)	
Combination EFI-P2 - 1 pc + KZS-1M - 10 pcs (bottom connection).		1P+N	12	0,22	002921155 SKN0032/10 (1p+N)	
Combination EFI-P4 - 1 pc + KZS-1M - 10 pcs (bottom connection).		3P+N	12	0,25	002921156 SKN0034/10 (3p+N)	
Type of equipment	Wiring diagram	Type	No. of modules	Length [m]	Fork (FORK type)	
					10mm ² (63A)	16mm ² (100A)
Motor protective circuit breakers: - MS25, - MPE25 (up to 40A).		3P	6	0,09	002921298 IZM 45-2	
			9	0,13	002921299 IZM 45-3	
			12	0,18	002921300 IZM 45-4 002921130 IZM10/3F/4xMPE	002921132 IZM16/3F/4xMPE
			15	0,22	002921301 IZM 45-5	
			60	1,00	002921131 IZM10/3F/20xMPE	002921133 IZM16/3F/20xMPE
Motor protective circuit breakers: - MS25 + BC, - MPE25 (up to 40A) + BC, - MSP0 (up to 25A, (without accessories)).		3P	6	0,10	002921302 IZM 54-2	
			9	0,15	002921303 IZM 54-3	
			12	0,21	002921304 IZM 54-4	
			15	0,22	002921305 IZM 54-5	
Type of equipment	Wiring diagram	Type	No. of modules	Length [m]	Pin (PIN type)	
					10mm ² (63A)	16mm ² (100A)
Fuse-switch disconnectors (17,8 mm wide): - EFD8, PCF 8, - EFD10, PCF 10.		1P	12	0,21	002921100 IZS10/1F/12	002921110 IZS16/1F/12
			54	1,00	002921101 IZS10/1F/54	002921111 IZS16/1F/54
		3P	12	0,21	002921102 IZS10/3F/12	002921112 IZS16/3F/12
			54	1,00	002921103 IZS10/3F/54	002921113 IZS16/3F/54
Type of equipment	Wiring diagram	Type	No. of modules	Length [m]	Pin (PIN type)	
					25mm ² (100A)	35mm ² (125A)
Fuse-switch disconnectors, fuse holders (17,8 mm wide): - EFD8, PCF 8, - EFD10, EFH 10 1000V DC.		1P	57	1,01	002921290 IZS25/1F/57 (angle 600V AC/1000V DC)	002921291 IZS35/1F/57 (angle 600V AC/1500V DC)
Type of equipment	Wiring diagram	Type	No. of modules	Length [m]	Pin (PIN type)	
					35mm ² (125A)	
Fuse holders: - EFH 10/14 1500V DC.		1P	46	1,02	002921292 IZS 35/1F/16 (angle 600V AC/1500V DC)	
Type of equipment	Wiring diagram	Type	No. of modules	Length [m]	Pin (PIN type)	
					16mm ² (80A/130A)	50mm ² (160A/250A)
Fuse-switch disconnectors, fuse holders (27 mm wide): - EFD 14, EFH 14 1000V DC, - PFB D01, PFB D02.		1P	37	0,98	002921250 IZ16/1F/37 (angle)	002921251 IZ50/1F/37 (angle)
					002921121 IZ16/1F/36V (angle 1000V DC)	
		3P	39	1,05	002921254 IZ16/3F/39	002921255 IZ50/3F/39
Type of equipment	Wiring diagram	Type	No. of modules	Length [m]	Pin (PIN type)	
					16mm ² (80A/130A)	50mm ² (160A/250A)
Fuse-switch disconnectors (35,6 mm wide): - EFD 22.		1P	28	0,98	002921260 IZ16/1F/28 (angle)	002921261 IZ50/1F/28 (angle)
					3P	30

Dimensions

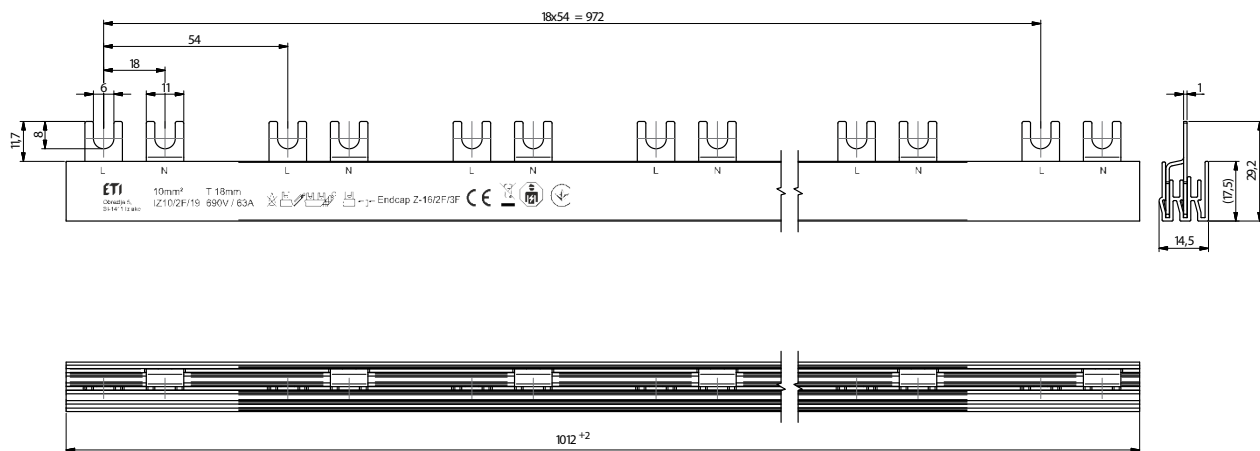
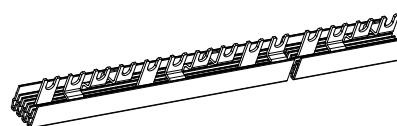
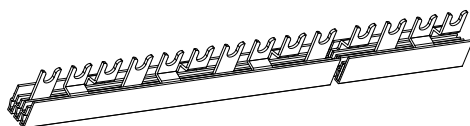
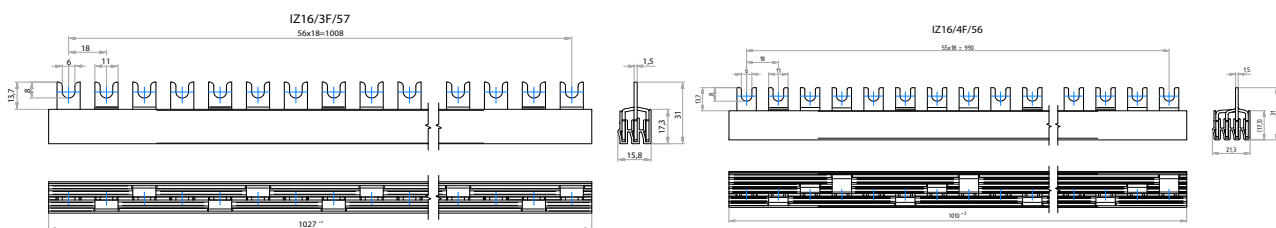
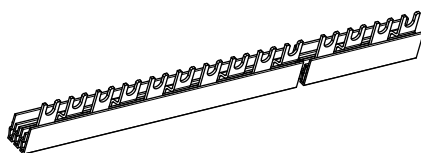
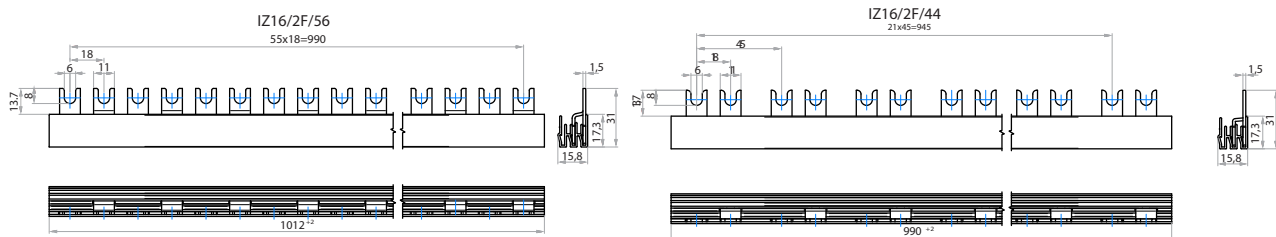

IZ10/2F/19

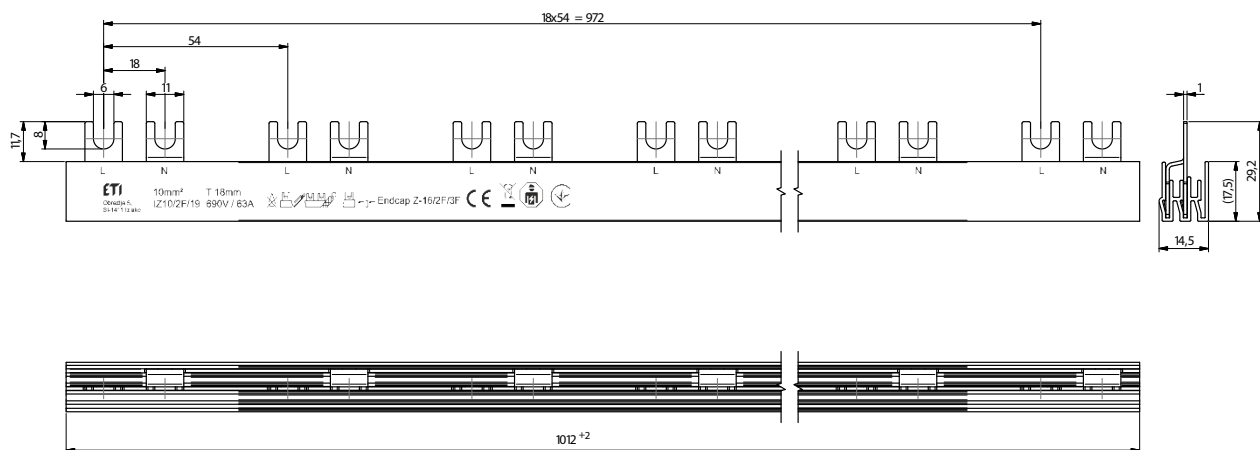

IZ10/4F/18

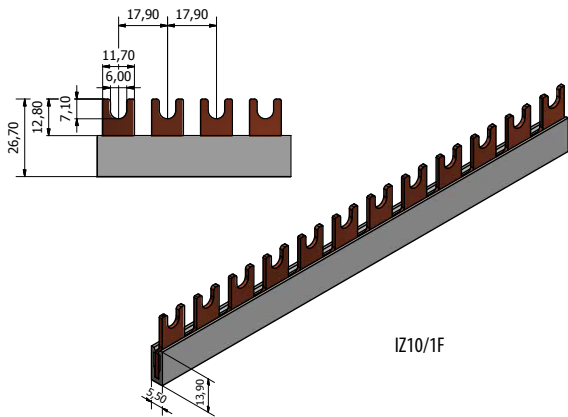

IZ10/1F

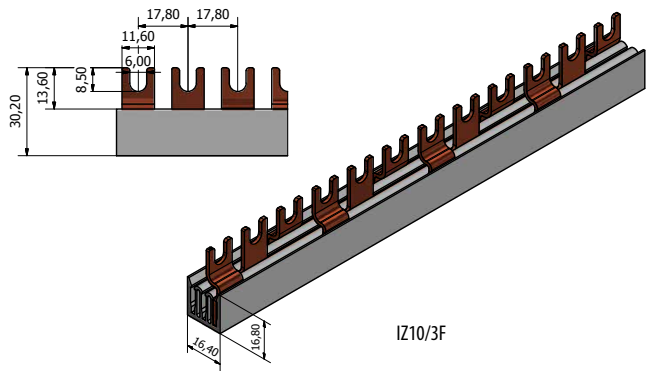

IZ10/3F

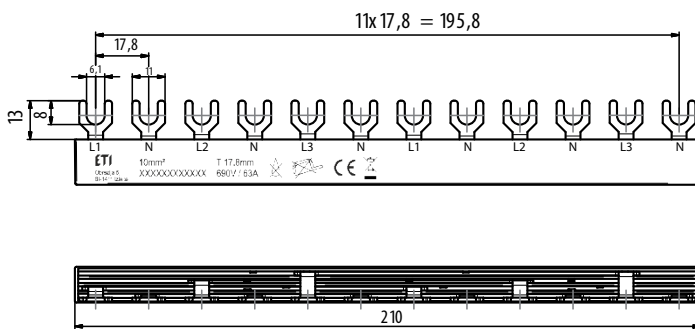

IZ10/L1N1L2N1L3N/12

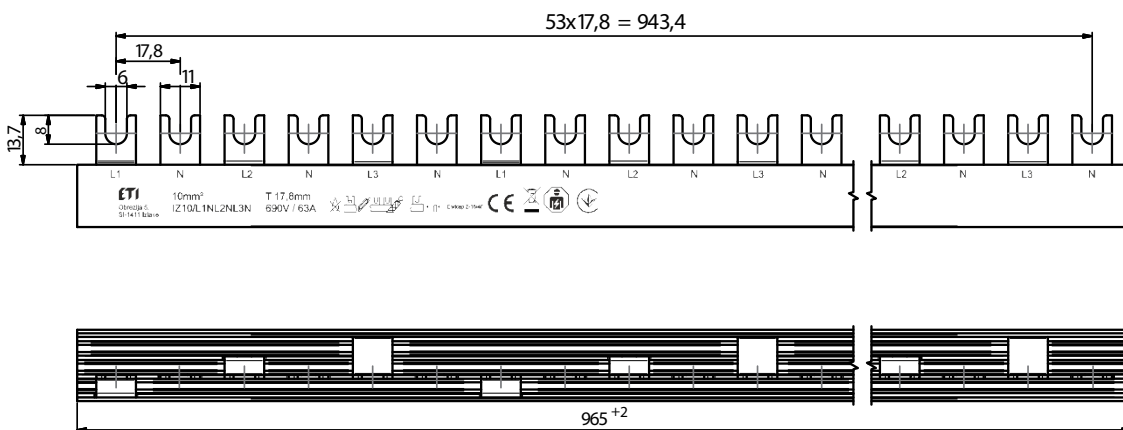
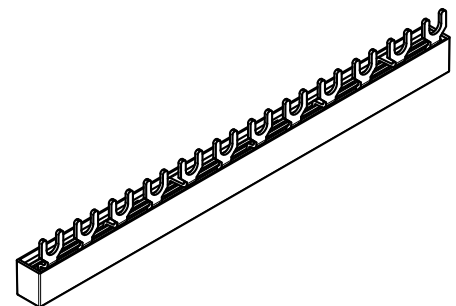
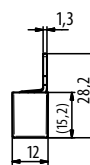

IZ10/L1N1L2N1L3N

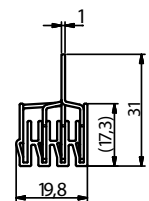

Accessories

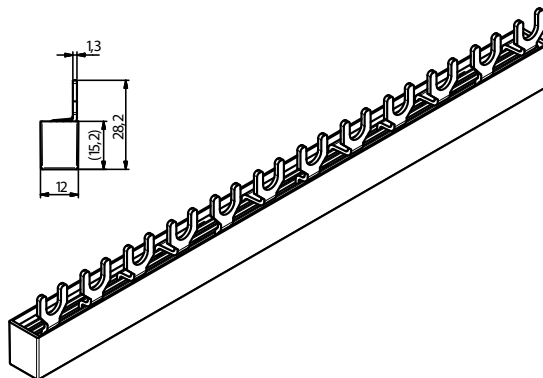
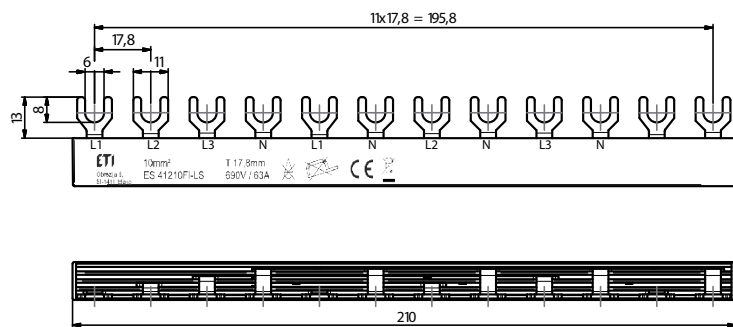

IZ10/L1L2L3NL1NL2NL3N

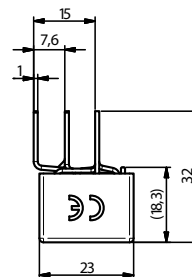
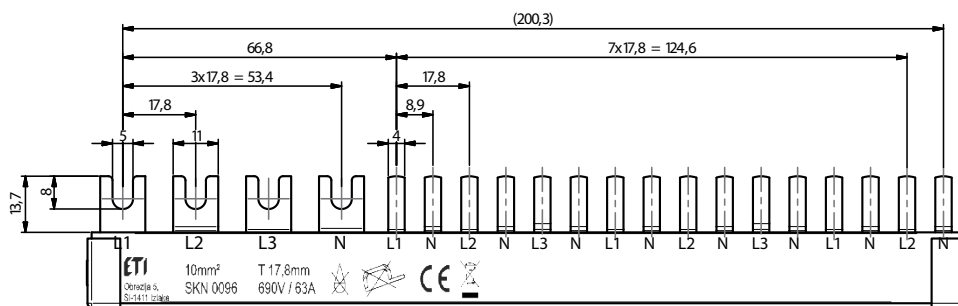

IZ10/L1L2L3NL1/NL2/NL3/N

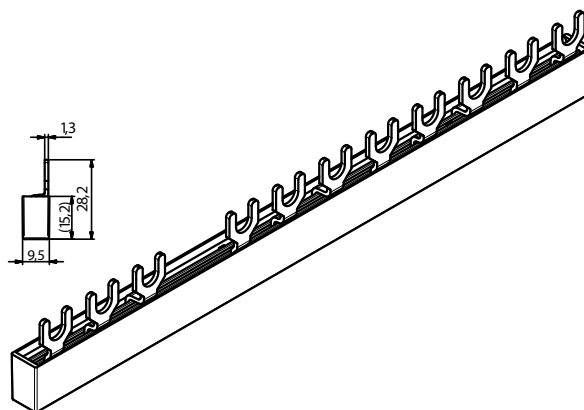
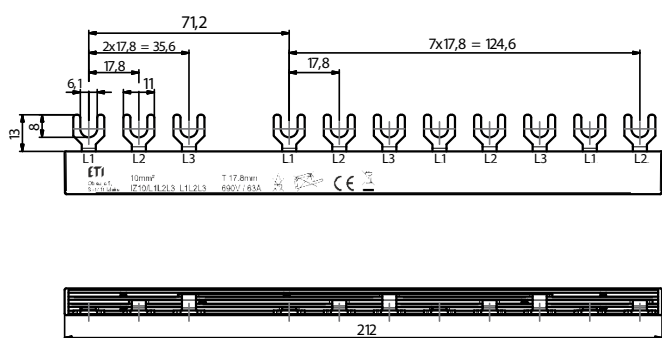

IZ10/L1L2L3_L1L2L3

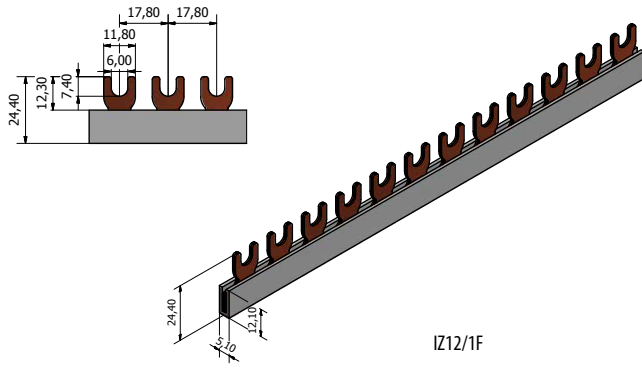

IZ12/1F

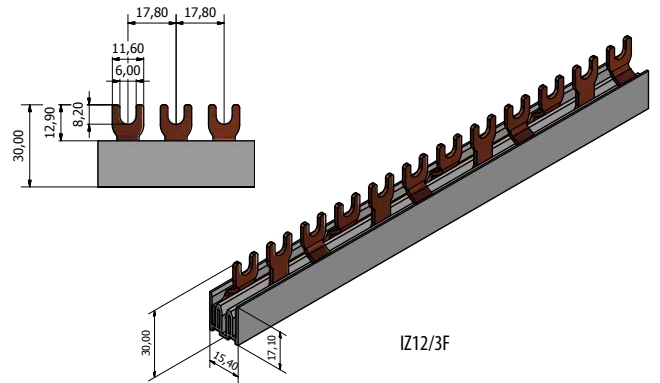

IZ12/3F

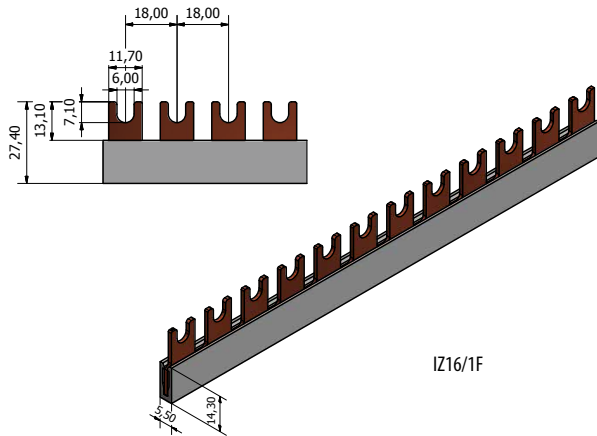

IZ16/1F

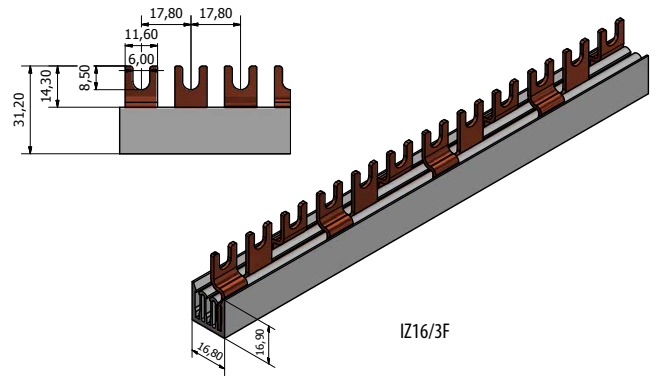

IZ16/3F

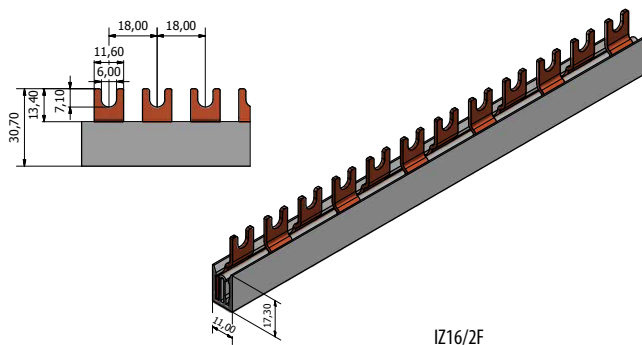

IZ16/2F

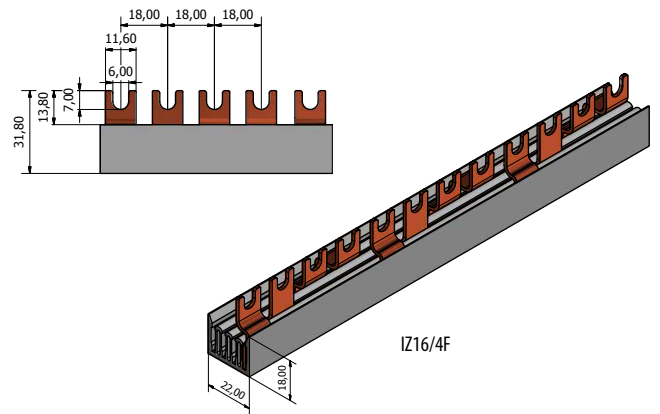

IZ16/4F

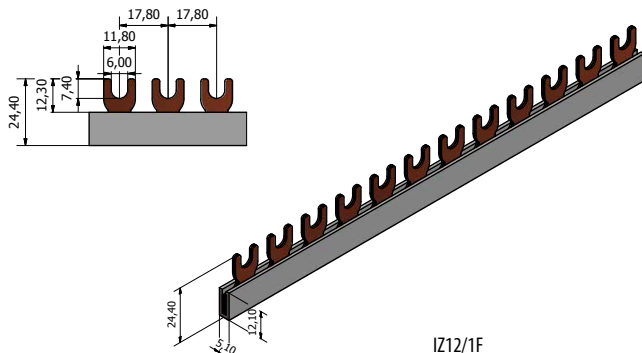

IZ12/1F

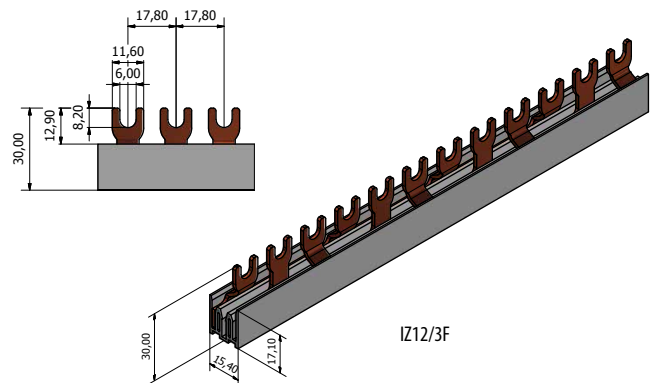

IZ12/3F

Accessories

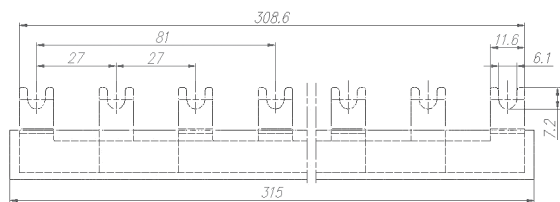

IZ16_3F_12_STV

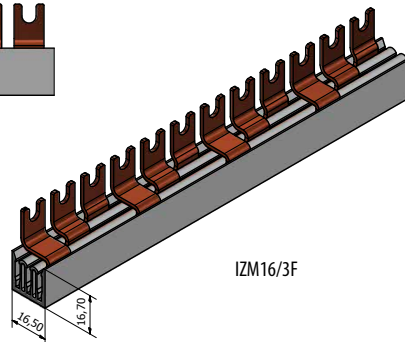
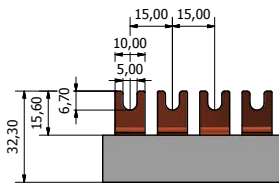

IZM16/3F

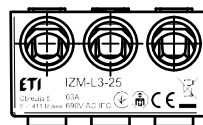
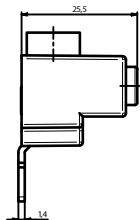
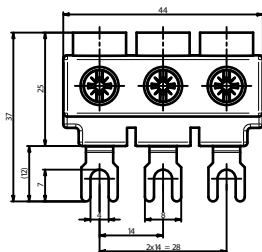

IZM-L3-25

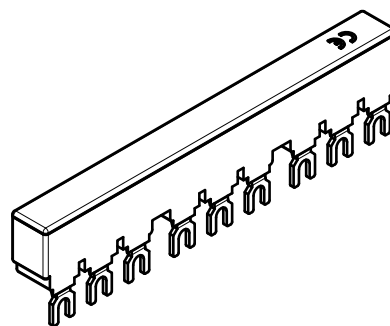
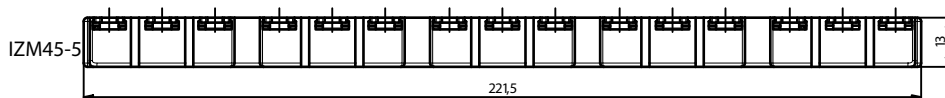
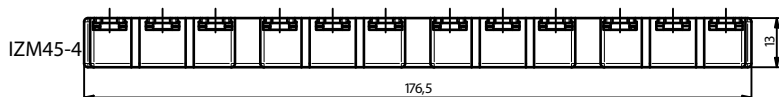
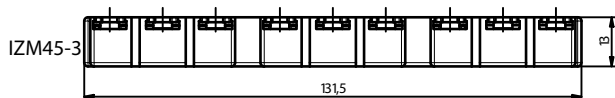
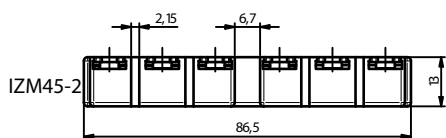
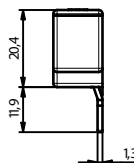
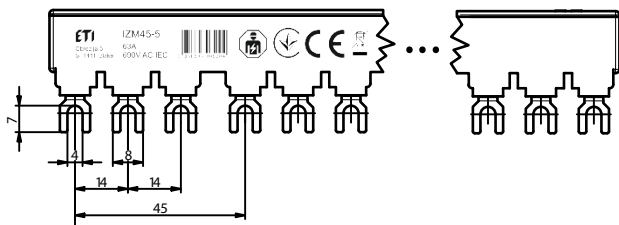

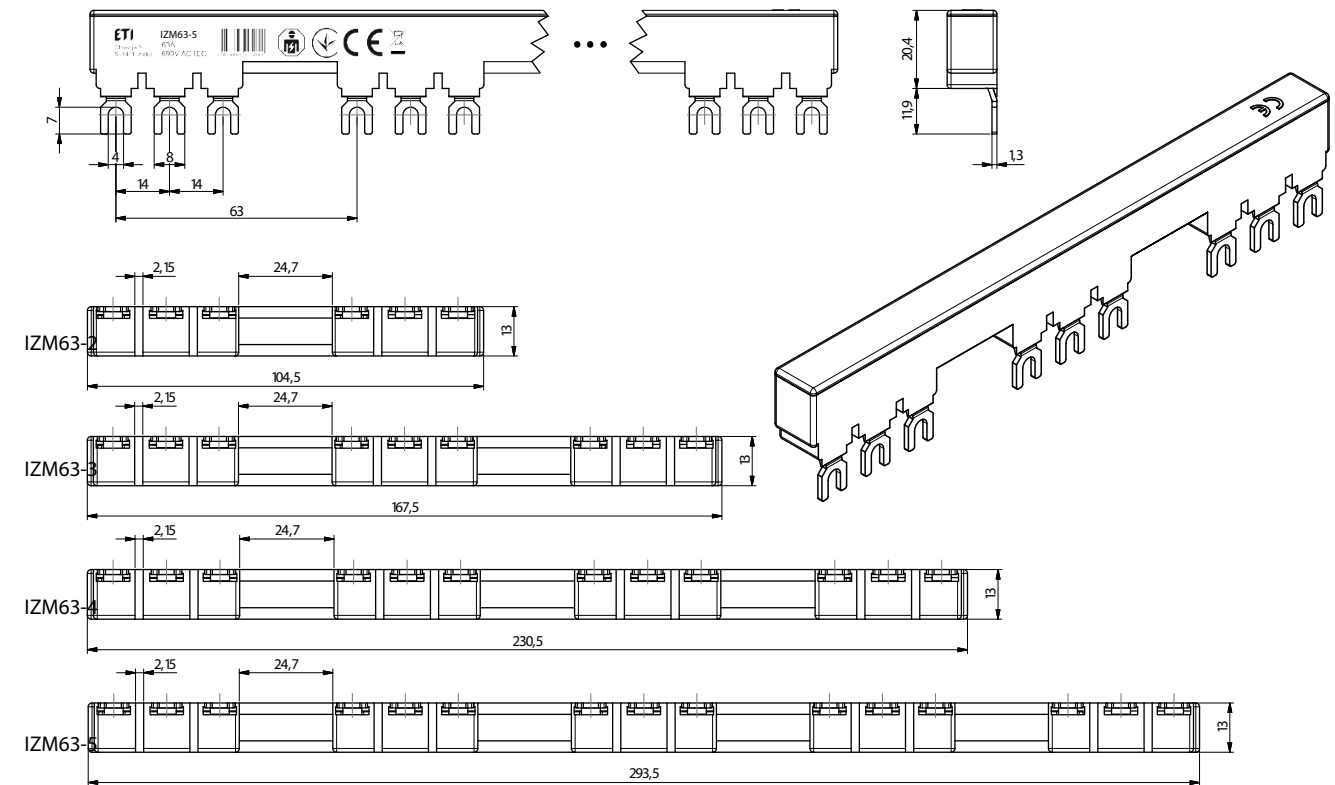
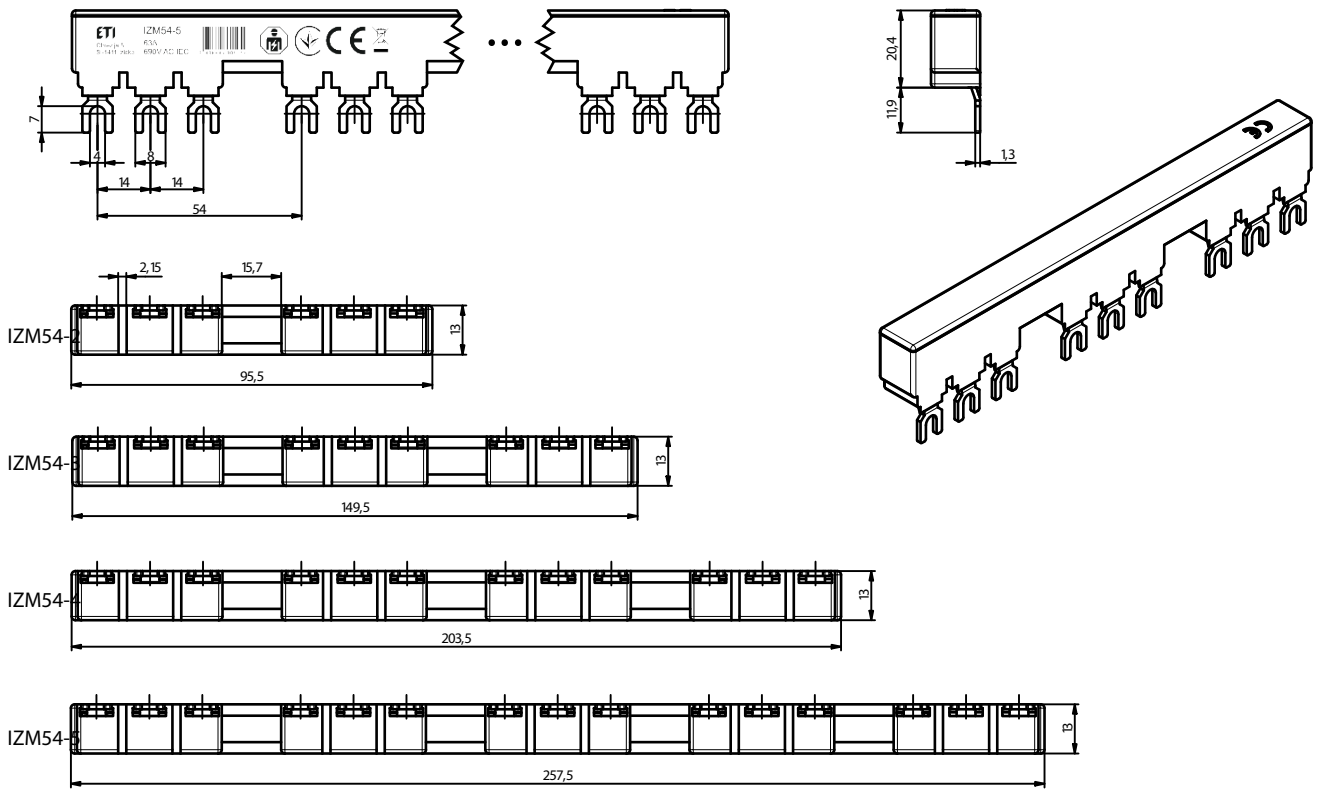

Pin type

IZ-S rails

Nominal voltage	max. 500V	cross section	Rated current (A)
Dielectric strength	2,5 kV	10 mm ²	63
Insulating resistance	> 5 MΩ (DIN 53482)	12 mm ²	80
Temperature range	-20°C ... + 50°C	16 mm ²	100
Glow wire test	850°C (IEC 695-2-1)		
Self-extinguishing	V-0		
Standards	EN 60947-7-1		

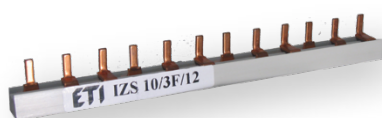

Phase busbars 10 mm² (normal) 63A

Type	Additional description	Code No.	Cross section [mm ²]	Length [m]	Weight [g]	Packaging [pcs]	For use with
IZS10/1F/12	10mm ² , 1-phase, 12 mod.	002921100	10	0,21	40	40/480	ETIMAT6,
IZS10/1F/54*	10mm ² , 1-phase, 54 mod.	002921101	10	1,00	150	40	ETIMAT P10,
IZS10/3F/12	10mm ² , 3-phase, 12 mod.	002921102	10	0,21	100	20/240	ETITEC,SV,VLD01,
IZS10/3F/54*	10mm ² , 3-phase, 54 mod.	002921103	10	1,00	450	20	PCF8, PCF10, EFD8, EFD10

*Not for ETIMAT P10 MULTIPOLE(2P, 3P, 1P+N, 3P+N) with length more than 12 modules.

Phase busbars 16 mm² (normal) 100A

Type	Additional description	Code No.	Cross section [mm ²]	Length [m]	Weight [g]	Packaging [pcs]	For use with
IZS16/1F/12	16mm ² , 1-phase, 12 mod.	002921110	16	0,21	50	40/480	ETIMAT6,
IZS16/1F/54*	16mm ² , 1-phase, 54 mod.	002921111	16	1,00	220	40	ETIMAT P10,
IZS16/3F/12	16mm ² , 3-phase, 12 mod.	002921112	16	0,21	130	20/180	ETITEC,SV,VLD01,
IZS16/3F/18*	16mm ² , 3-phase, 18 mod.	002921113	16	0,32	230	20/120	PCF8, PCF10,
IZS16/3F/54*	16mm ² , 3-phase, 54 mod.	002921114	16	1,00	700	20	EFD8, EFD10

*Not for ETIMAT P10 MULTIPOLE(2P, 3P, 1P+N, 3P+N) with length more than 12 modules.

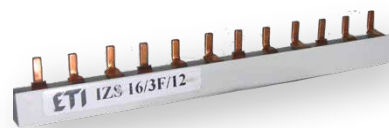

Technical data - Section rails for EFD

Cross section	16 mm ²	50 mm ²
Feeding at beginning/ending		
Max. current I _s /Phase	80	160
Cross section of connection, mm ²	16	50
Feeding in the middle		
Max. current I _e /Phase	130	250
Cross section of connection, mm ²	35	2x50
Heat deflection temperature PVC	80°C flame resistant	
Comparative tracking index PVC	300V	
Standards	EN 60947-1:2007 / IEC 60947-1:2007	
Climate stability	DIN EN 60068	
Insulation coordination	Degree of pollution 2	
Electrical data		
Impulse voltage strength	≥4,5 kV	
Min. air distance	> 5,5 mm	
Min. creeping distance	> 5 mm	
Max. operating voltage	690 V AC/DC	
Protection class	IP20	
Short circuit rating	ICC 15kA NH 250A gL 500V	
Dielectric strength	≥ 32 kV/mm	
Material		
	Material	Surface
Busbar	Copper	plain
Insulation	PVC lead-free	grey RAL 7035
Endcover	moulded	

Phase busbars 16mm² 80A(side connection)/130A (middle connection)

Type	Additional description	Code No.	Cross section [mm ²]	Length [m]	Weight [g]	Packaging [pcs]	For use with
IZS16/1F/37	1 p, 37 mod.	002921250	16	0,981	320	10	EFD14, EFH14,
IZS16/3F/39	3 p, 39 mod.	002921254	16	1,045	760	10	PFB D02/D01
IZS16/1F/28	1 p, 28 mod.	002921260	16	0,976	320	10	EFD22
IZS16/3F/30	3 p, 30 mod.	002921264	16	1,05	1050	10	



Phase busbars 25mm² 100A(side connection)/200A (middle connection)

Type	Additional description	Code No.	Cross section [mm ²]	Length [m]	Weight [g]	Packaging [pcs]	For use with
IZS 25/1F/57	1 p, 57 mod.	002921290	25	1,012	365	10	ETIMAT, SV, ETITEC, EFD8/10, EFH10



Phase busbars 35mm² 125A(side connection)/200A (middle connection)

Type	Additional description	Code No.	Cross section [mm ²]	Length [m]	Weight [g]	Packaging [pcs]	For use with
IZS 35/1F/57	1 p, 57 mod.	002921291	35	1,016	400	25	ETIMAT, SV, ETITEC, EFD8/10, EFH10
IZS 35/1F/46	1 p, 46 mod.	002921292	35	1,016	400	10	EFH 10/14

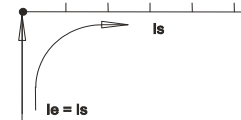

Feeding at beginning / ending

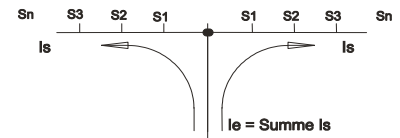

Feeding in the middle

In case of center-feeding, please note that the sum of junction currents S1...Sn per rail branch may not be bigger than the above named max. currents Is/Phase.

Phase busbars 50mm² 160A(side connection)/250A (middle connection)

Type	Additional description	Code No.	Cross section [mm ²]	Length [m]	Weight [g]	Packaging [pcs]	For use with
IZS50/1F/37	1 p, 37 mod.	002921251	50	0,981	750	10	EFD14, EFH14,
IZS50/3F/39	3 p, 39 mod.	002921255	50	1,045	2190	10	PFB D02/D01
IZS50/1F/28	1 p, 28 mod.	002921261	50	0,976	770	10	EFD22
IZS50/3F/30	3 p, 30 mod.	002921265	50	1,05	2320	10	

1. ATTENTION: To prevent electrical shock, disconnect from power source before installing or servicing.

2. Danger: Installation by electricians only

3. Due to security purposes all shortened busbars need to be covered with suitable endcovers.

4. Burr

5. Clean

6. Attach end cover

Accessories

IZ16/1F/37

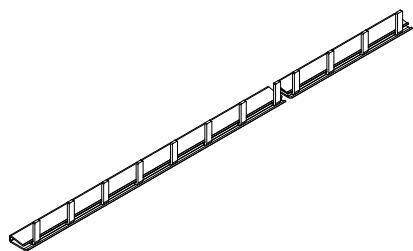
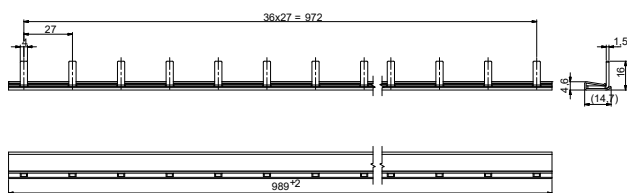

IZ16/3F/37

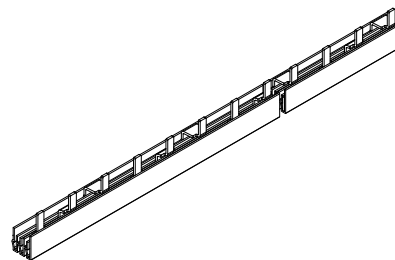
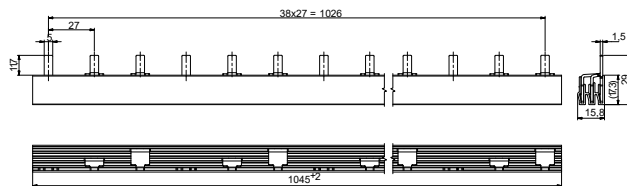

IZ16/1F/28

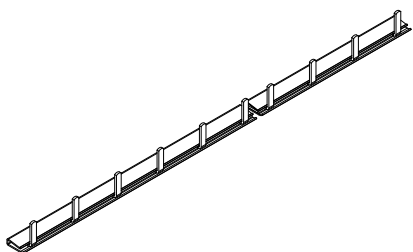
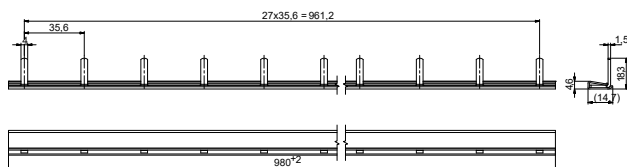

IZ16/3F/28

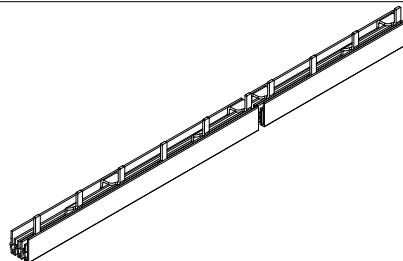
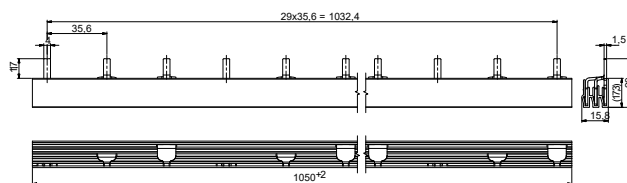

IZS 25/1F/57

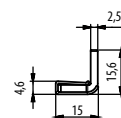
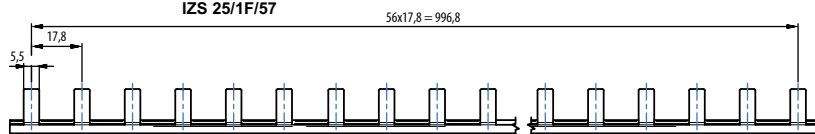

IZS 35/1F/57

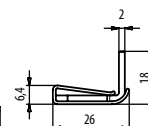
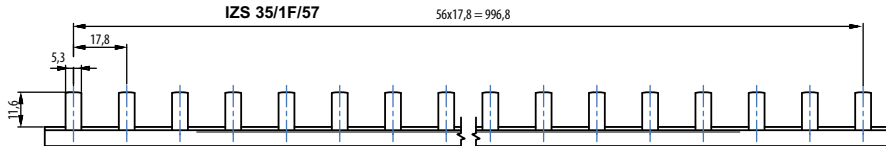

IZ 35/1F/46

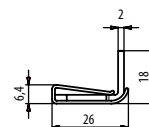
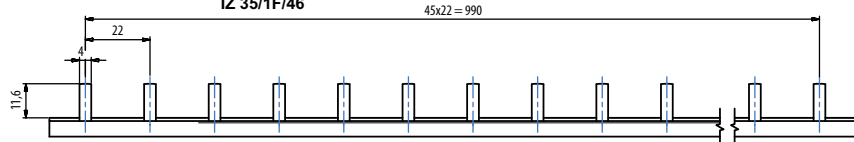

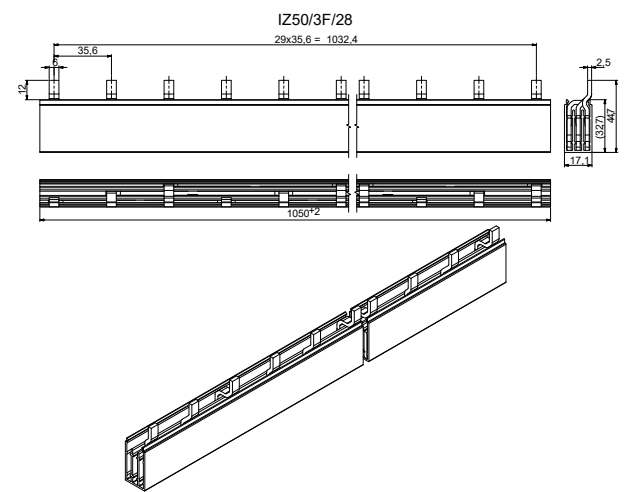
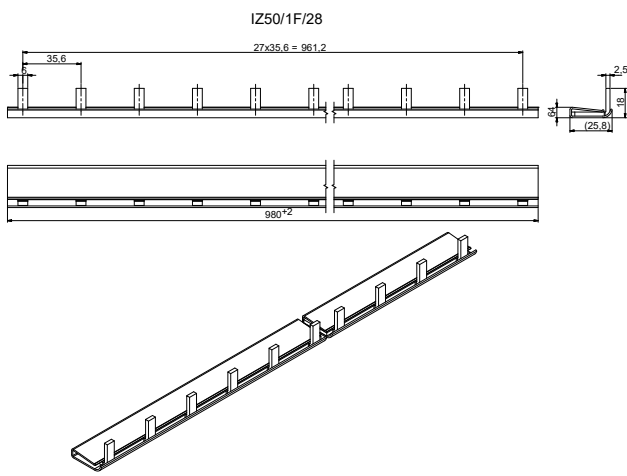
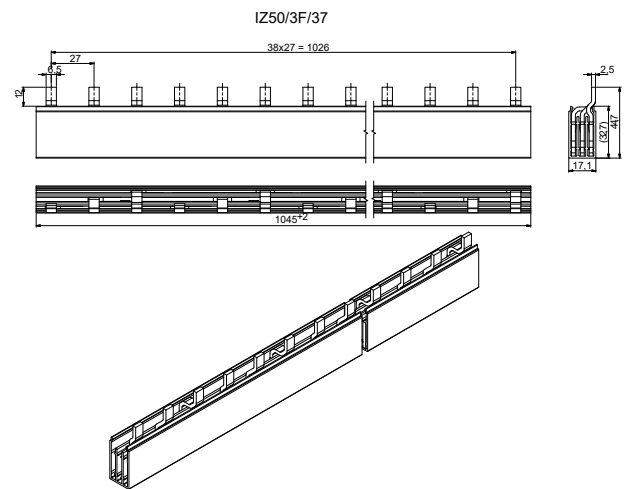
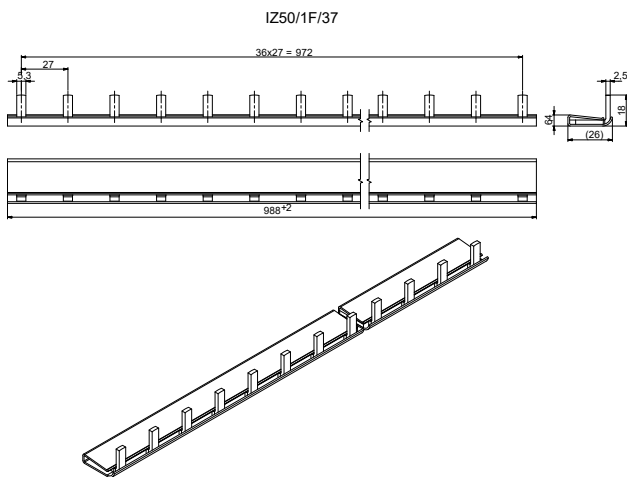

SKN type

Phase busbars 10 mm² (normal) 63A

Type	Additional description	Code No.	Cross section [mm ²]	Length [m]	Weight [g]	Packaging [pcs]	For use with
SKN0021/10	10mm ² , 1p+N, 12 mod.	002921150	10	0,216	203	10	ETIMAT1N, KZS1M
SKN0029/103P	10mm ² , 3p+N, 12 mod.	002921154	10	0,216	292	10	
SKN0032/10	10mm ² , 1p+N, 12 mod.	002921155	10	0,21	160	10	EF12+10xETIMAT1N
SKN0034/103P	10mm ² , 3p+N, 14 mod.	002921156	10	0,252	378	10	EF14+10xETIMAT1N

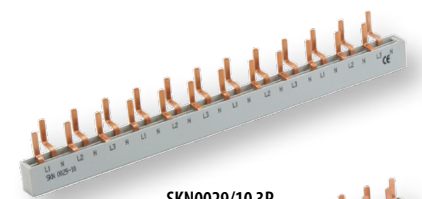

SKN0029/10 3P

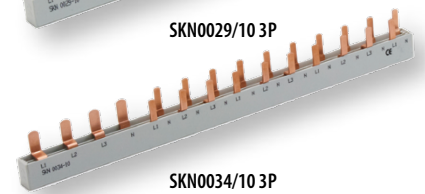

SKN0034/10 3P

Accessories

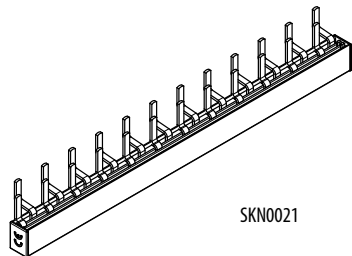
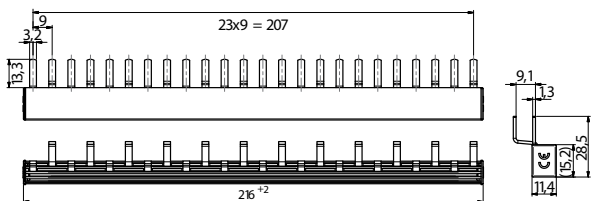

SKN0021

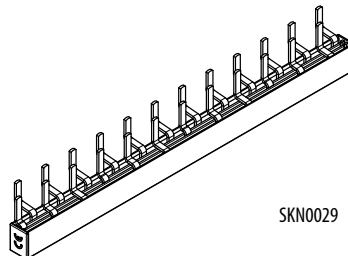
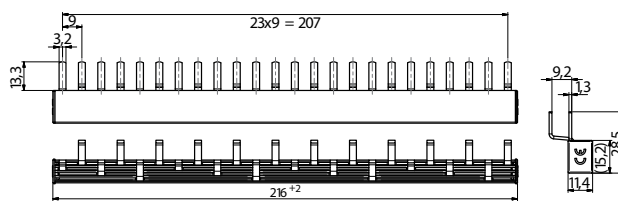

SKN0029

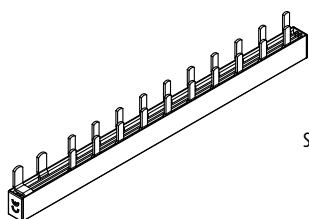
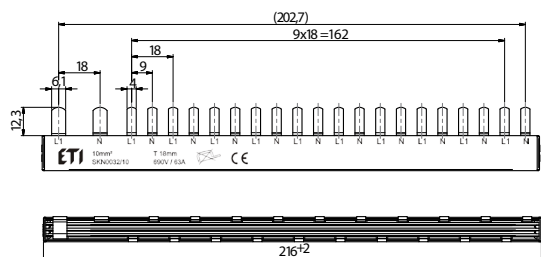

SKN0032

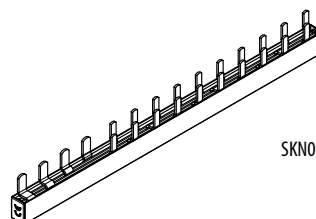
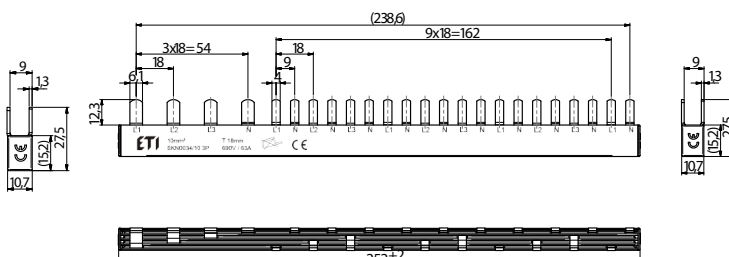

SKN0034 3P

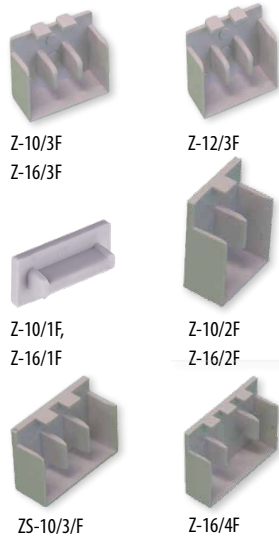

End cover cap

Type	Code No.	Weight [g]	Packaging [pcs]	For use with
Z-10/1F	002921220	0,15	25/250	IZ10/1F (002921143, 002921142), IZ10/3F/D (002921160, 002921161), IZM10/3F/D (002921190, 002921191)
Z-10/3F	002921227	0,8	25/250	IZ10/3F (002921140, 002921141), IZM10/3F (002921130, 002921131)
ZS-10/3F	002921226	0,8	25/250	IZS10/3F (002921102, 002921103)
Z-12/1F	002921221	0,15	25/250	IZ12/1F (002921018, 002921026), IZ12/3F/D (002921162, 002921163, 002921164)
Z-12/3F	002921019	0,7	25/250	IZ12/3F (002921017, 002921020, 002921022, 002921024)
Z-16/1F	002921222	0,15	25/250	IZ16/1F (002921091, 002921092), IZ16/3F/D (002921064, 002921065), IZ16/2F/D (002921200, 002921201), IZ16/4F/D (002921210, 002921211), IZM16/3F/D (002921192, 002921193), IZ16/1F/STV (002921071, 002921073)
Z-16/1F	002921252	1,6	50	IZS16/1F/37 (002921250), IZS16/1F/28 (002921260)
Z-16/1F/L	002921205	1,0	25	IZ16/1F/...L (002921081, 002921082, 002921083, 002921060, 002921062)
Z-16/2F	002921224	0,5	25/250	IZ16/2F (002921066, 002921067)
Z-16/2F/3F (18)	002921240	3,0	50	IZ10/2F/19 (002921294), IZ16/2F/56 (002921230), IZ16/3F/57 (002921231), IZ16/2F/44 (002921233), IZS16/3F/30 (002921264), IZS16/3F/39 (002921254)
Z-16/3F	002921228	0,8	25/250	IZ16/3F (002921061, 002921063), IZM16/3F (002921132, 002921133), IZ16/3F/STV (002921072, 002921074)
ZS-16/3F	002921204	0,8	25/250	IZ16/3F (002921061, 002921063), IZM16/3F (002921132, 002921133), IZ16/3F/STV (002921072, 002921074)
Z-16/4F	002921225	1	25/250	IZ16/4F (002921068, 002921070)
Z-16/4F (18)	002921241	2,0	50	IZ10/4F/18 (002921295), IZ16/4F/56 (002921232), IZ10/L1NL2NL3N/54 (002921279)
ZS-16/4F	002921229	1	25/250	IZS16/4F (002921177, 002921178)
Z-25/1F	002921293	1	25	IZS 25/1F/57 (002921290)
Z-50/1F	002921253	3,2	50	IZS50/1F/37 (002921251), IZS35/1F/57 (002921291)
*Z-50/1F/28	002921263	5,6	25	IZS50/1F/28 (002921261), IZS35/1F/46 (002921292)
Z-50/3F	002921267	4,4	50	IZS50/3F/30 (002921265), IZS50/3F/39 (002921255)

*Under 1 reference code, 1 pair is included (left and right side cover)

Z-16/1F/37

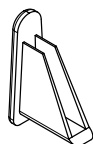
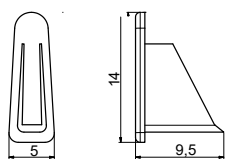

Z-50/1F/37

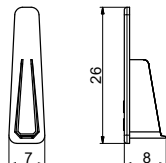

Z-50/3F/39

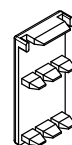
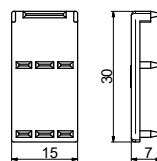

Z-16/1F/28

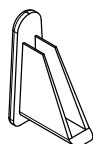
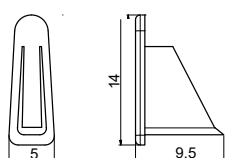

Z-50/1F/28

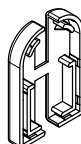
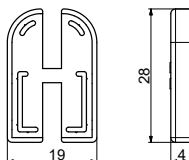

Z-50/3F/30

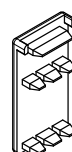
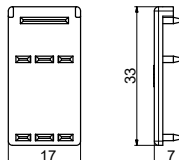

DIN rails

Type	Code No.	Length [m]	Weight [g]	Packaging [pcs]	For use with
TH35/L - 1m	002911022	1,00	312	10/50	All modular products
TH35/L - 2m	002911023	2,00	624	10/30	
TH35/A - 1m	002911024	1,00	312	10/50	
TH35/A - 2m	002911025	2,00	624	10/30	

L - Normal quality of galvanic cover – mat

A - Better quality of galvanic cover – shinning

Marking lath

Code No.	Length [m]	width [mm]	Weight [g]	Packaging [pcs]
002911007	1	12	40,7	50

Cover lath

Code No.	Length [m]	opening [mm]	Weight [g]	Packaging [pcs]
002911003	0,217	46 ^{+0.5}	24,4	500

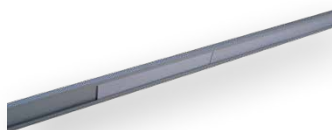

DIN rail distribution blocks EDB

Construction

- // Brass screw terminal blocks double-deck
- // Housing made of self extinguishing material
- // Cover and separating made of polycarbonate

Application

Proper and transparent connecting cables in low voltage distribution boards

Advantages

- // TH35 din rail mounted or on a flat surface
- // Safe and easy installation
- // Transparent cover
- // 2 or 4 pole model
- // Self extinguishing material
- // Possibility of connecting wires with ferrules or without



EDB-407

Technical data:

Degree of protection	IP20 (with closed cover)
Short circuit withstand capability I_{sc}	20kA
Rated current	125A
In accordance with	EN 60947-1, EN 60947-7-1

Wire cross section by terminal size

Wire with ferrule	Wire without ferrule	Terminal size [mm]
1,5 - 6 mm ²	2,5 - 6 mm ²	Ø 5,3
6 - 16 mm ²	10 - 25 mm ²	Ø 7,5
10 - 16 mm ²	10 - 35 mm ²	Ø 9

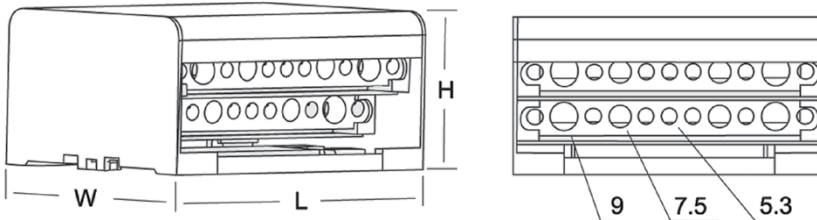

Distribution blocks EDB

Type	Code No.	Number of terminals	I_n [A]	Dimensions L x W x H [mm]	Weight [kg]	Packaging
2 - poles						
EDB-207	001102300	2 x (5 x Ø 5,3 + 2 x Ø 7,5)	125A	65 x 42 x 50	0,14	1/100
EDB-211	001102301	2 x (7 x Ø 5,3 + 2 x Ø 7,5 + 2 x Ø 9)	125A	100 x 42 x 50	0,18	1/100
EDB-215	001102302	2 x (11 x Ø 5,3 + 2 x Ø 7,5 + 2 x Ø 9)	125A	133 x 42 x 50	0,22	1/50
4 - poles						
EDB-407	001102303	4 x (5 x Ø 5,3 + 2 x Ø 7,5)	125A	65 x 88 x 50	0,24	1/100
EDB-411	001102304	4 x (7 x Ø 5,3 + 2 x Ø 7,5 + 2 x Ø 9)	125A	100 x 88 x 50	0,34	1/50
EDB-415	001102305	4 x (11 x Ø 5,3 + 2 x Ø 7,5 + 2 x Ø 9)	125A	133 x 88 x 50	0,46	1/50

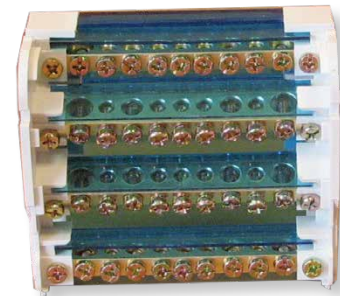

EDB-411



EDB-215

Ordering:

EDB - xyy

No. of Poles

Number of terminals per pole

DIN rail distribution blocks EDBM, EDBS

Build

- Brass or aluminum terminals
- Wires screwed by hex key (Allen key)
- Housing made of flame retardant material PA6 GF25

Application

- For connecting the phase and neutral conductors in LV

switchboards for proper and lucid distribution of electric energy

Advantages

- Mounted on a TH rail or on a flat surface with screws with low head
- Strong and simple mounting
- Terminal material:
EDBM – MO-58 brass
EDBS – 6060 aluminum

Housing: PA6 GF25 fire retardant

General Specifications:

- Rated impulse voltage withstand 6 kV
- Rated insulation voltage 690 V
- Number of poles 1
- The CTI factor 600 V
- Compliance with IEC 60947-7-1



EDBM-1, EDBM-1/N, EDBM-1/PE - 50 mm²

Input	Output	Cables cross section		Tightening torque
		Rigid	Flexible	
1	1	4-50 mm ²	6-50 mm ²	21 mm
	3	2,5-25 mm ²	4-25 mm ²	17 mm
	4	2,5-16 mm ²	2,5-16 mm ²	9 mm
Type	Code No	Weight [g]	Packaging [pcs]	
EDBM-1	001102400	225	1/5/100	
EDBM-1/N	001102410	225	1/5/100	
EDBM-1/PE	001102411	225	1/5/100	

Parameters:

Rated cross section 50 mm², Rated current 160 A, Allen keys 3 mm, 4 mm, 6 mm



EDBM-2, EDBM-2/N, EDBM-2/PE - 50 mm²

Input	Output	Cables cross section		Tightening torque
		Rigid	Flexible	
1	1	4-50 mm ²	6-50 mm ²	21 mm
	2	4-35 mm ²	6-25 mm ²	25 mm
	3	2,5-25 mm ²	2,5-16 mm ²	12 mm
Type	Code No	Weight [g]	Packaging [pcs]	
EDBM-2	001102401	225	1/5/100	
EDBM-2/N	001102412	225	1/5/100	
EDBM-2/PE	001102413	225	1/5/100	

Parameters:

Rated cross section 50 mm², Rated current 160 A, Allen keys 3 mm, 5 mm, 6 mm



EDBM-4, EDBM-4/N, EDBM-4/PE - 70 mm²

Input	Output	Cables cross section		Tightening torque
		Rigid	Flexible	
1	3	4-70 mm ²	6-50 mm ²	20 mm
	Type	Code No	Weight [g]	Packaging [pcs]
EDBM-4	001102402	215	1/5/100	
EDBM-4/N	001102414	215	1/5/100	
EDBM-4/PE	001102415	215	1/5/100	

Parameters:

Rated cross section 70 mm², Rated current 192 A, Allen keys 6 mm



EDBM-6, EDBM-6/N, EDBM-6/PE - 70 mm²

Input	Output	Cables cross section		Tightening torque
		Rigid	Flexible	
1	1	4-70 mm ²	6-50 mm ²	24 mm
	2	4-50 mm ²	6-35 mm ²	20 mm
	1	4-25 mm ²	6-25 mm ²	20 mm
Type	Code No	Weight [g]	Packaging [pcs]	
EDBM-6	001102403	215	1/5/100	
EDBM-6/N	001102416	215	1/5/100	
EDBM-6/PE	001102417	215	1/5/100	

Parameters:

Rated cross section 70 mm², Rated current 192 A, Allen keys 4 mm, 5 mm, 6 mm

EDBM-7, EDBM-7/N, EDBM-7/PE - 70 mm²

Input	Output	Cables cross section			Tightening torque
		Rigid	Flexible		
1	1	4-70 mm ²	6-50 mm ²	21 mm	14 Nm
	3	2,5-25 mm ²	4-25 mm ²	17 mm	6 Nm
	4	2,5-16 mm ²	2,5-16 mm ²	9 mm	3 Nm
Type	Code No	Weight [g]	Packaging [pcs]		
EDBM-7	001102422	225	1/5/100		
EDBM-7/N	001102423	225	1/5/100		
EDBM-7/PE	001102424	225	1/5/100		



Parameters:

Rated cross section 70 mm², Rated current 192 A, Allen keys 3 mm, 4 mm, 6 mm

EDBM-8, EDBM-8/N, EDBM-8/PE - 70 mm²

Input	Output	Cables cross section			Tightening torque
		Rigid	Flexible		
1	1	4-70 mm ²	6-50 mm ²	21 mm	14 Nm
	2	4-35 mm ²	6-25 mm ²	25 mm	10 Nm
	3	2,5-25 mm ²	2,5-16 mm ²	12 mm	3 Nm
Type	Code No	Weight [g]	Packaging [pcs]		
EDBM-8	001102425	225	1/5/100		
EDBM-8/N	001102426	225	1/5/100		
EDBM-8/PE	001102427	225	1/5/100		



Parameters:

Rated cross section 70 mm², Rated current 192 A, Allen keys 3 mm, 5 mm, 6 mm

EDBS-50A, EDBS-50A/N, EDBS-50A/PE, EDBS-50B, EDBS-50B/N, EDBS-50B/PE

Input	Output	Cables cross section			Tightening torque
		Rigid	Flexible		
1	1	16-70 mm ²	25-50 mm ²	20 mm	10 Nm
Type	Code No	Weight [g]	Packaging [pcs]		
EDBS-50A	001102404	225	1/5/100		
EDBS-50A/N	001102418	225	1/5/100		
EDBS-50A/PE	001102419	225	1/5/100		
Type	Code No	Weight [g]	Packaging [pcs]		
EDBS-50B	001102405	225	1/5/100		
EDBS-50B/N	001102420	225	1/5/100		
EDBS-50B/PE	001102421	225	1/5/100		



Parameters:

Rated cross section 50 mm², Rated current 150 A, Allen key 5 mm

Input - 6060 Aluminum (EDBS-50A version ...), with a protective coat (version EDBS-50B ...)

For Al and Cu cables

Accessories

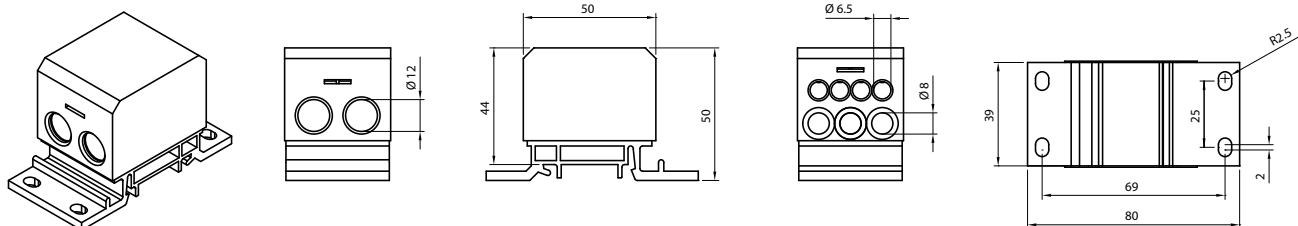
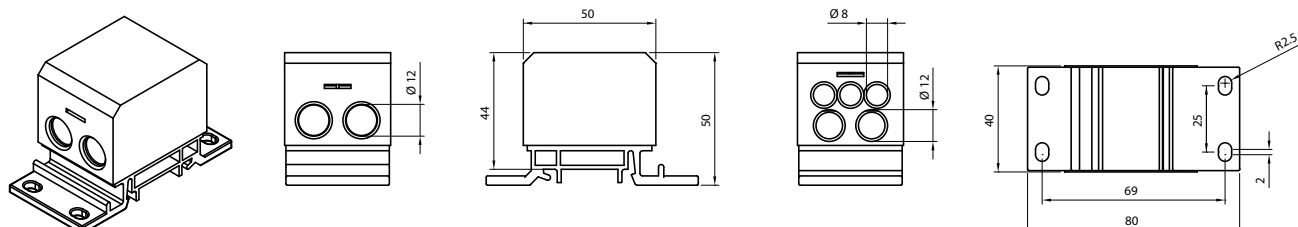
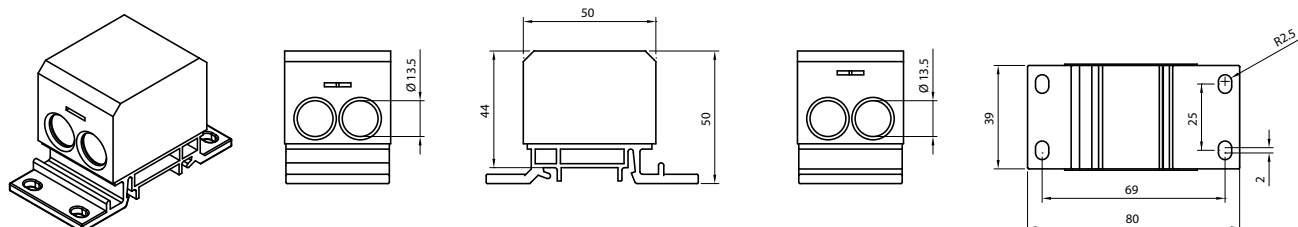
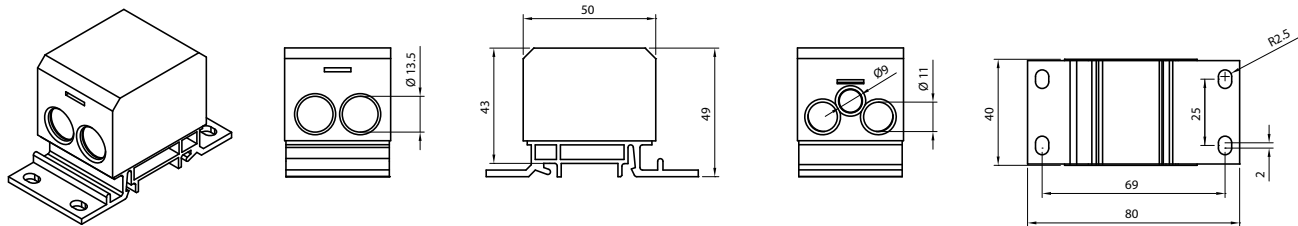
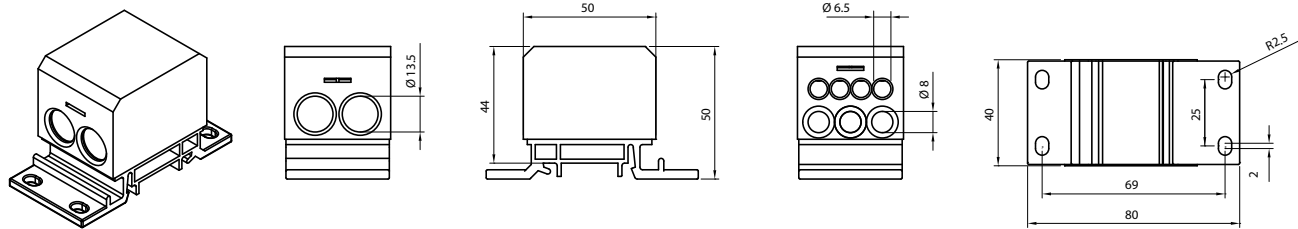
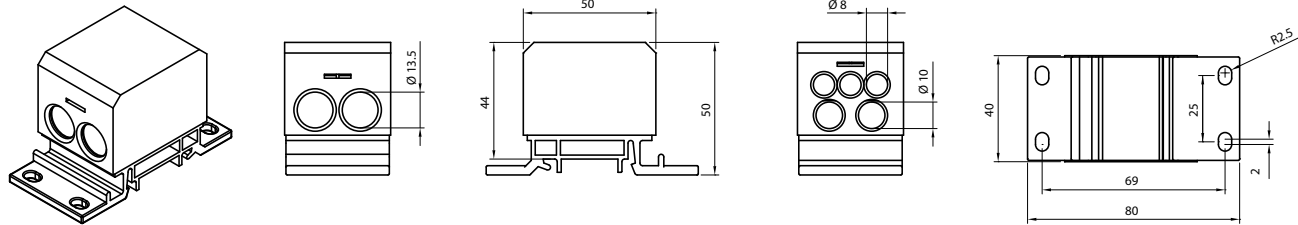
EDBM-1, EDBM-1/N, EDBM-1/PE - 50 mm²EDBM-2, EDBM-2/N, EDBM-2/PE - 50 mm²EDBM-4, EDBM-4/N, EDBM-4/PE - 70 mm²EDBM-6, EDBM-6/N, EDBM-6/PE - 70 mm²EDBM-7, EDBM-7/N, EDBM-7/PE - 70 mm²EDBM-8, EDBM-8/N, EDBM-8/PE - 70 mm²

EDBS-50.., EDBS-50../N, EDBS-50../PE

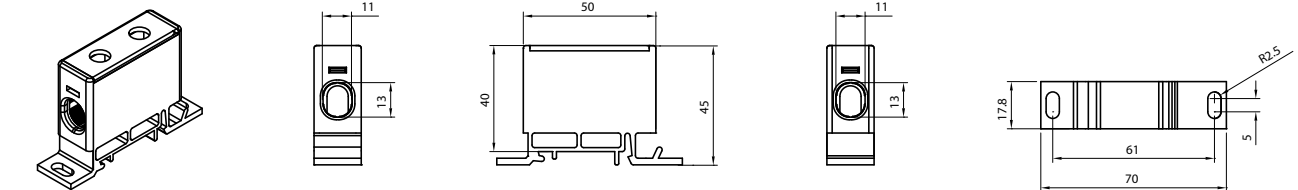

Equipotential terminal boards ESC-QBLOK

Equipotential terminal boards

Partition rail assemblies are used as supplementary rail assemblies for phase or neutral expansion inside electrical panels. They are also known as equipotential rail assemblies because they are used as equipotential nodes in distribution control units to collect the earth system.

General features

Available in 7 and 12 hole versions

Mounted onto PR/3 profiles conforming to IEC 60715 standards, TH/35 type
 Inherent protection against accidental contact
 IPXXB level according to IEC 60529
 Possible to label with a CNU/8 tag
 Available in green and blue
 Conformance to EN 60998-1:2004 and EN 60998-2-1:2004 regulations
 Insulating body made of 6.6 UL94V-0 polyamide

Technical data for ESC-QBLOK Series

	ESC-QBLOK7001	ESC-QBLOK7002	ESC-QBLOK1201	ESC-QBLOK1202
TECHNICAL CHARACTERISTICS				
function / type	Distribution rail assembly			
rated cross-section (mm ²)	10			
connecting capacity:				
flexible(mm ²)	1,5 ÷ 10			
rigid(mm ²)	1,5 ÷ 16			
max. flexible with ferrule (mm ²)-ferrule type	10 - WP100/21			
rated voltage / rated current / gauge conf. to IEC 60947-7-1	500 V / 63 A / B5			
rated impulse withstand voltage / pollution degree	-			
insulation stripping length (mm)	6			
tightening torque value (test / max) (Nm)	2 / 2,5			
height / width / thickness	TH/35 7,5 mm		33 - 85 - 16	
height / width / thickness	TH/35 15 mm		41 - 85 - 16	
Color	blue	green	blue	green

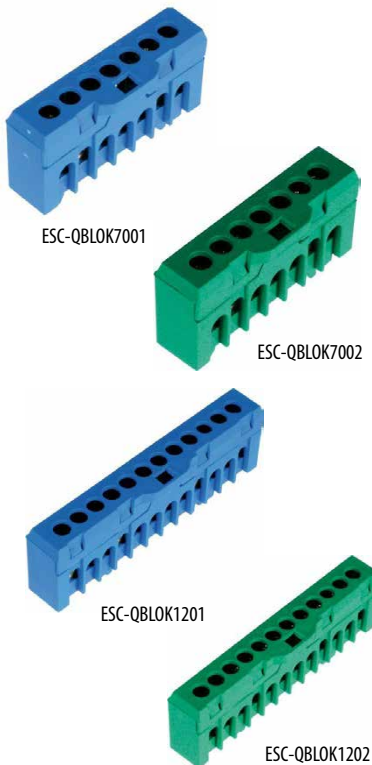

Equipotential distribution terminal boards

Type	Code No.	Description	Weight [g]	Packaging [pcs]
ESC-QBLOK7001	003903204	for Conductor Flexible/Rigid (10/16)mm ² , 7 holes, Blue	45	10
ESC-QBLOK7002	003903205	for Conductor Flexible/Rigid (10/16)mm ² , 7 holes, Green	45	10
ESC-QBLOK1201	003903206	for Conductor Flexible/Rigid (10/16)mm ² , 12 holes, Blue	28	10
ESC-QBLOK1202	003903207	for Conductor Flexible/Rigid (10/16)mm ² , 12 holes, Green	28	10

DIN rail distribution blocks EDBJ

Build

- ▀ The blocks consist of an insert / clamp made of brass or aluminum and a housing made of plastic.
- ▀ The terminals are equipped with screws with a hex key (Allen key)

Advantages

- ▀ mounted on a TH rail
- ▀ easy to assemble
- ▀ 1 module width !!
- ▀ strong connection

Application

- ▀ For connecting the phase and neutral conductors in LV switchboards for proper and lucid distribution of electric energy

General Specifications

- ▀ Rated impulse withstand voltage 6 kV (EDBJ-4x25-4x25, EDBJ-1x70-4x25), 12kV (EDBJ-

1x35-1x35)

- ▀ Rated insulation voltage 1000 V
- ▀ Number of poles - 1
- ▀ Rated voltage 240/415 V
- ▀ Terminal material:
 - brass MO-58 (EDBJ-4x25-4x25, EDBJ-1x70-4x25)
 - aluminum 6060 zinc plated (EDBJ-1x35-1x35)
- ▀ Housing material:
 - PC / ABS plastic (for EDBJ-4x25-4x25, EDBJ-

- 1x70-4x25)
- PA6.6 plastic (for EDBJ-1x35-1x35)
- ▀ Flammability class V0
- ▀ possibility of sealing (for EDBJ-4x25-4x25, EDBJ-1x70-4x25)
- ▀ Working temperature -30°C to +80°C
- ▀ Compliance with IEC 60947-7-1

EDBJ-4x25-4x25

Cables cross section					Tightening torque
Upper	Bottom	Rigid	Flexible		
4	4	25 mm ²	16 mm ²	16 mm	6 Nm
Type	Code No	Weight [g]	Packaging [pcs]		
EDBJ-4x25-4x25	001102428	125	1/12/240		
EDBJ-4x25-4x25N	001102429	125	1/12/240		
EDBJ-4x25-4x25PE	001102430	125	1/12/240		

Parameters:

Rated cross section 25mm², Rated current 100 A, Allen keys 3 mm

EDBJ-1x70-4x25

Cables cross section					Tightening torque
Upper	Bottom	Rigid	Flexible		
1		4-70 mm ²	6-50 mm ²	25 mm	10 Nm
	4	2,5-25 mm ²	2,5-16 mm ²	16 mm	6 Nm
Type	Code No	Weight [g]	Packaging [pcs]		
EDBJ-1x70-4x25	001102434	117	1/12/240		
EDBJ-1x70-4x25N	001102435	117	1/12/240		
EDBJ-1x70-4x25PE	001102436	117	1/12/240		

Parameters:

Rated cross section 70 mm², Rated current 192 A, Allen keys 3 mm, 5 mm

EDBJ-1x35-1x35

Cables cross section					Tightening torque
Upper	Bottom	Rigid	Flexible		
1	1	2,5-35 mm ²	2,5 - 25 mm ²	21 mm	6 Nm
Type	Code No	Weight [g]	Packaging [pcs]		
EDBJ-1x35-1x35	001102431	27	1/12/300		
EDBJ-1x35-1x35N	001102432	27	1/12/300		
EDBJ-1x35-1x35PE	001102433	27	1/12/300		

Parameters:

Rated cross section 35 mm², Rated current 125 A, Allen keys 3 mm,
The galvanic coating of the insert enables the connection of both Al and Cu conductors



EDBJ-4x25-4x25



EDBJ-4x25-4x25N



EDBJ-4x25-4x25PE



EDBJ-1x70-4x25



EDBJ-1x70-4x25N



EDBJ-1x70-4x25PE



EDBJ-1x35-1x35



EDBJ-1x35-1x35N



EDBJ-1x35-1x35PE

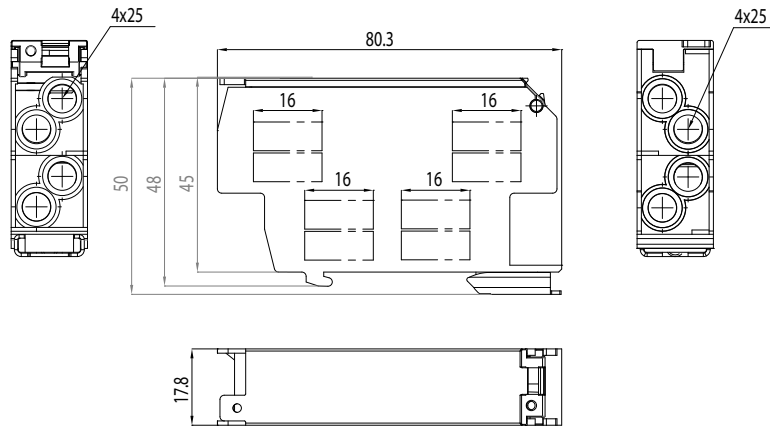

EDBJ-4x25-4x25..

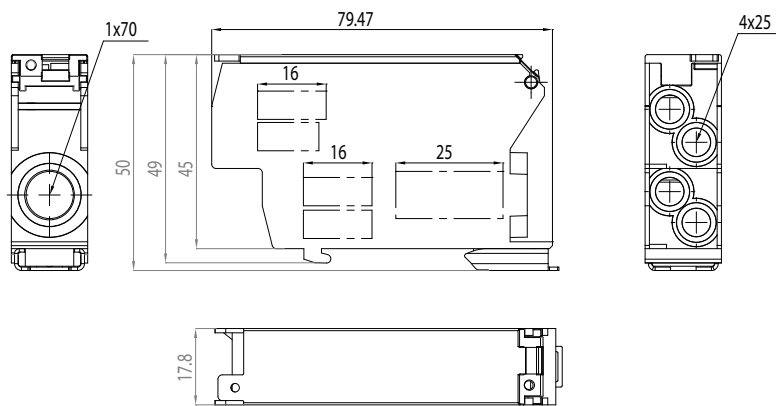

EDBJ-1x70-4x25...

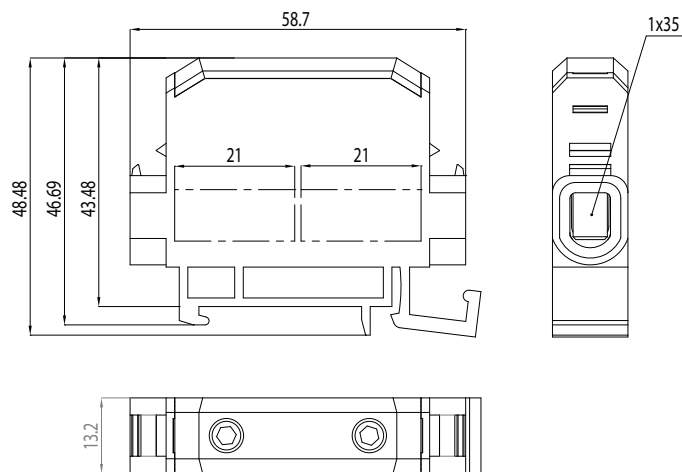

EDBJ-1x35-1x35

Meter board

Instructions for mounting a meter board

- // Fasten the frame of the meter board using four screws and plastic wall inserts. While drilling holes, take care not to damage electrical wires.
- // When the board is fixed, attach a meter using bolts with sliding nuts.
- // Fasten the wires in the terminals and position the protective cover.



VPO



VP

Meter board

Type	Code No.	Weight [g]	Packaging [pcs]
MPO	001117001	508	1/25
VPO	001117002	690	1/16
MP	001117004	276	1/25
VP	001117005	453	1/16
ENB2	001101197	350	15

MPO - small meter board

VPO - large meter board

MP - small meter board without frame

VP - large meter board without frame



ENB2

METER board

type	dimension					
	A	B	C	D	E	F
MPO	250	80	85	47	63	170
VPO	370	75	170	136	50	241
MP	250	80	85	47	63	270
VP	370	75	170	136	50	241

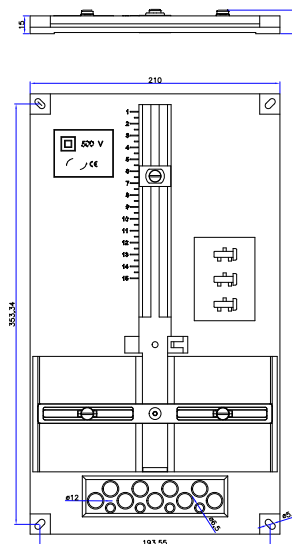
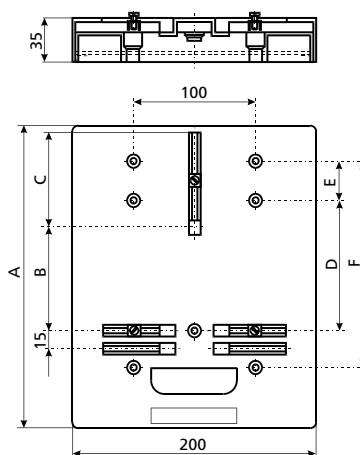

Universal board covering UPO

Standard length of profile
1 m

The covering UPO is the improved form for covering the space between rows of built-in elements in distribution boards. The built-in elements are installed on the mounting rails with width of 35 mm which shall be mounted in the distance of 125 mm.

Description - UPO covering consists of terminal plates that should be fixed on mounting rails, and flat and corner profiles, which are click-on mounted on the terminal plates. The space between rows of apparatuses is covered by a flat profile. Upper and lower rows of devices should be covered by corner profile.

Technical data:

Standard length of profile	1 m
Number of carriers per 1 m of profile	4 pcs
Distance between mounting rails	125 mm
Width of distance for built-in elements	46 + 0,5 mm

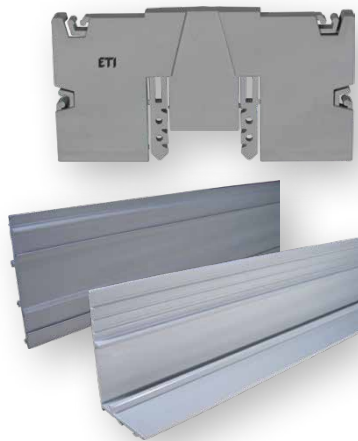

Universal board covering UPO

Type	Code No.	Weight [g]	Packaging [pcs]
Terminal plate	001214011	50	18
Flat profile	001214012	15	322
Corner profile	001214013	10	306

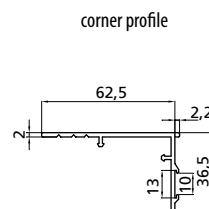
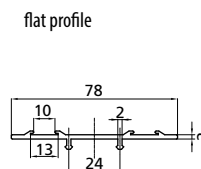
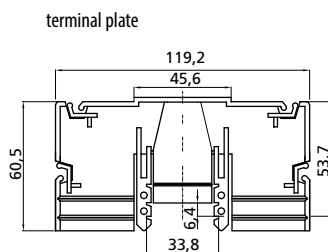

Installation channels

Technical data

Material	PVC, halogen free	
Dimensions	Height	15, 25, 30, 40, 60, 80, 100, 125, 150
	Width	15, 25, 40, 60, 80, 100
Length	2 m	
Colour	RAL 7030	
Tensile strength	390 kg/cm ²	
Dielectric strength	36 kV/mm	
Installation temperature	< 70 °C	
Electrical resistance	6,1 x 10 ¹⁴ Ω/cm	
Flammability	UL 94 V0	
Halogen free	IEC 60754-2	
Directive	RoHS	
Marking	CE	

Marking

Cover → B 40x60 T
 sealing type
 B
 A
 Dimension (width x height)

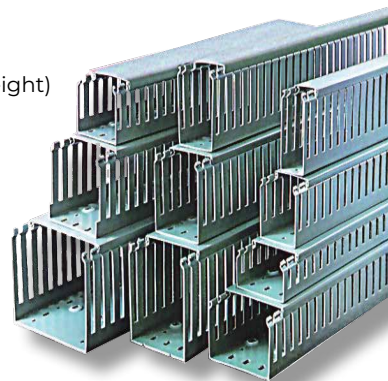

Type B cover sealing

Type	Code No.	Weight [g]	Packaging [pcs]
B 25x40 T	003911034	520	36
B 25x60 T	003911035	620	18
B 25x80 T	003911036	980	18
B 40x40 T	003911037	700	18
B 40x60 T	003911038	840	18
B 40x80 T	003911039	980	18
B 40x100 T	003911040	1225	12
B 48x100 T	003911041	6030	4
B 55x100 T	003911042	3020	4
B 60x40 T	003911043	613	18
B 60x60 T	003911044	1040	12
B 60x80 T	003911045	1480	12
B 60x100 T	003911046	1720	8
B 75x100 T	003911047	1706	8
B 80x40 T	003911048	1160	12
B 80x60 T	003911049	1420	12
B 80x80 T	003911050	1720	12
B 80x100 T	003911051	1790	8
B 100x60 T	003911052	1760	8
B 100x80 T	003911053	1860	8
B 100x100 T	003911054	2120	8
B 150x100 T	003911055	3200	4

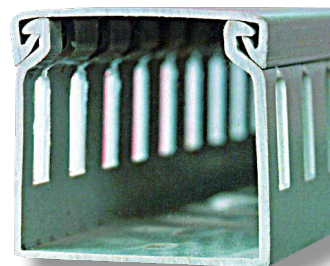
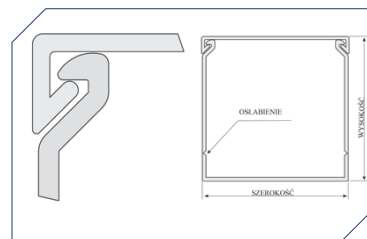

Type A cover sealing

Type	Code No.	Weight [g]	Packaging [pcs]
A 25x25 T	003911003	540	48
A 25x30 T	003911004	600	48

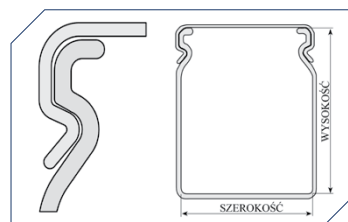

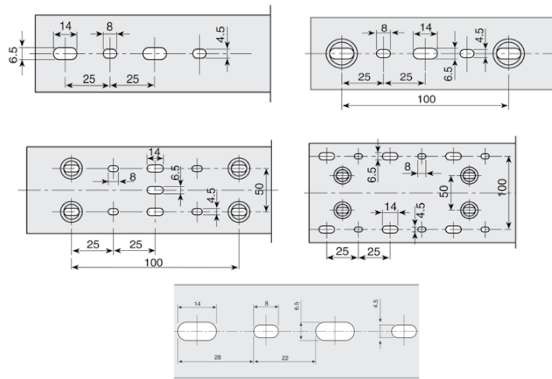

Side perforation

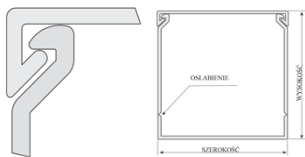
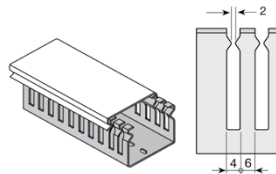

Type B cover sealing

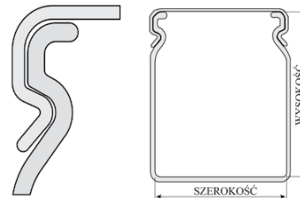

Type A cover sealing

Mounting insulators

Rated voltage
250-3600 V

Rated impulse voltage
8-50kV

Application

Support insulators are intended for installation in el. enclosures for supporting busbars and/or other current leading parts. They provide electrical insulation. They are made of red fiber-reinforced polyester glass, which guarantees high resistance and mechanical strength. On both sides, the insulator has threaded sleeves made of galvanized steel.

Technical data

Installation temperature	-20°C... +120°C
Material	BMC polyester halogen free
Flammability	VO (UL94)



Marking:

INS H x M x ES

H-Height M-hole diameter ES-External diameter of insulator

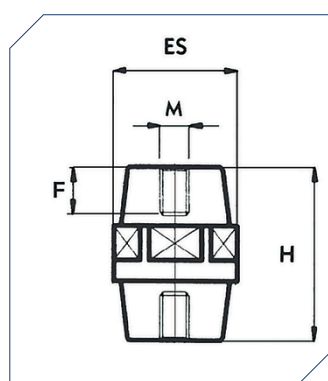

F-sleeve thread depth

Mounting insulators

Type	Code No.	Dimensions (mm)				Mechanical parameters			Electrical characteristics		Packaging [pcs]	Weight [g]
		H	M	ES	F	Tensile strenght [daN]	Cantilever strenght [daN]	Twisting strenght [Nm]	Operating voltage AC/DC [V]	Flashover voltage [kV]		
INS 1238	003810201	12	3	8	3,5	100	20	0,6	250	8	200	18
INS 15414	003810203	15	4	14	4,5	300	60	3	250	8	100	22
INS 15514	003810204	15	5	14	4,5	300	60	4	250	8	100	22
INS 16414	003810202	16	4	14	4,5	300	60	3	250	8	100	20
INS 20417	003810205	20	4	17	5	350	80	3	400	15	100	25
INS 20517	003810206	20	5	17	5	350	80	4	400	15	100	26
INS 20617	003810207	20	6	17	5	350	80	8	400	15	100	27
INS 25419	003810208	25	4	19	8	400	220	3	600	25	50	28
INS 25519	003810209	25	5	19	8	400	220	6	600	25	50	30
INS 25619	003810210	25	6	19	8	400	220	10	600	25	50	32
INS 25819	003810211	25	8	19	8	400	220	10	600	25	50	36
INS 30630	003810212	30	6	30	9	900	450	10	750	30	50	40
INS 30830	003810213	30	8	30	9	900	450	25	750	30	50	40
INS 35632	003810214	35	6	32	11	1100	500	10	750	40	50	44
INS 35832	003810216	35	8	32	11	1100	500	25	750	40	50	44
INS 351032	003810218	35	10	32	11	1100	500	50	750	40	50	44
INS 36641	003810215	36	6	41	11	1400	650	10	1000	40	50	48
INS 36841	003810217	36	8	41	11	1400	650	25	1000	40	50	48

Mounting insulators

Type	Code No.	Dimensions (mm)				Mechanical parameters			Electrical characteristics			
		H	M	ES	F	Tensile strenght [daN]	Cantilever strenght [daN]	Twisting strenght [Nm]	Operating voltage AC/DC [V]	Flashover voltage [kV]	Packaging [pcs]	Weight [g]
INS 361041	003810219	36	10	41	11	1400	650	50	1000	40	50	48
INS 40632	003810220	40	6	32	15	1100	500	10	1000	40	25	52
INS 40832	003810221	40	8	32	15	1100	500	25	1000	40	25	52
INS 401032	003810222	40	10	32	15	1100	500	50	1000	40	25	52
INS 401232	003810223	40	12	32	15	1100	500	87	1000	40	25	55
INS 45641	003810224	45	6	41	15	1400	740	10	1000	40	25	55
INS 45841	003810225	45	8	41	15	1400	740	25	1000	40	25	55
INS 451041	003810226	45	10	41	15	1400	740	50	1000	40	25	55
INS 45846	003810227	45	8	46	15	1500	750	10	1000	40	25	56
INS 451046	003810228	45	10	46	15	1500	750	25	1000	40	25	56
INS 451246	003810229	45	12	46	15	1500	750	50	1000	40	25	56
INS 50636	003810230	50	6	36	15	1300	650	10	1500	50	25	61
INS 50836	003810231	50	8	36	15	1300	650	25	1500	50	25	61
INS 501036	003810233	50	10	36	15	1300	650	50	1500	50	25	61
INS 50850	003810232	50	8	50	15	1500	750	25	1500	50	10	67
INS 501050	003810234	50	10	50	15	1500	750	50	1500	50	10	75
INS 501250	003810235	50	12	50	15	1500	750	87	1500	50	10	75
INS 55855	003810236	55	8	55	15	1600	780	25	1500	50	10	87
INS 551055	003810237	55	10	55	15	1600	780	50	1500	50	10	87
INS 551255	003810238	55	12	55	15	1600	780	87	1500	50	10	87
INS 60855	003810239	60	8	55	15	2000	800	25	1500	50	10	94
INS 601055	003810240	60	10	55	15	2000	800	50	1500	50	10	91
INS 601255	003810241	60	12	55	15	2000	800	87	1500	50	10	91
INS 63841	003810242	63	8	41	15	1600	700	25	1500	50	10	83
INS 631041	003810243	63	10	41	15	1600	700	50	1500	50	10	83
INS 65856	003810244	65	8	56	15	2000	800	25	2000	50	10	85
INS 651056	003810245	65	10	56	15	2000	800	50	2000	50	10	98
INS 651256	003810246	65	12	56	15	2000	800	87	2000	50	10	98
INS 701065	003810249	70	10	65	25	3000	1200	50	2000	50	5	103
INS 701265	003810247	70	12	65	25	3000	1200	87	2000	50	5	112
INS 701665	003810248	70	16	65	25	3000	1200	210	2000	50	5	115
INS 75850	003810253	75	8	50	15	1800	730	25	2000	50	5	114
INS 751050	003810250	75	10	50	25	1800	730	50	2000	50	5	112
INS 751250	003810255	75	12	50	25	1800	730	87	2000	50	5	114
INS 751065	003810254	75	10	65	25	3000	1200	50	2000	50	5	114
INS 751265	003810251	75	12	65	25	3000	1200	87	2000	50	5	112
INS 801065	003810256	80	10	65	25	3500	1300	50	3600	50	5	125
INS 801265	003810257	80	12	65	25	3500	1300	87	3600	50	5	125
INS 801665	003810258	80	16	65	25	3500	1300	210	3600	50	5	154
INS 1001065	003810259	100	10	65	25	4000	1300	50	3600	50	5	154
INS 1001265	003810260	100	12	65	25	4000	1300	87	3600	50	5	154
INS 1001665	003810261	100	16	65	25	4000	1300	210	3600	50	5	154

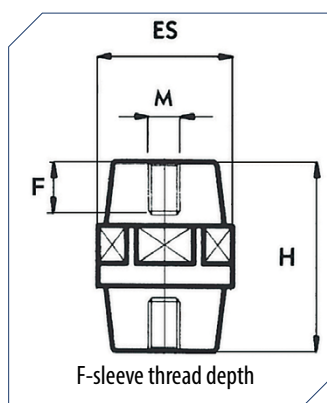

Metric cable glands IP67



Metric cable glands

Type	Description	Code No.	Weight [g]	Packaging [pcs]
M-12G	Metric cable gland M12	004482200	3	50
M-16G	Metric cable gland M16	004482201	5,6	50
M-20G	Metric cable gland M20	004482202	9,4	250
M-25G	Metric cable gland M25	004482203	19	150
M-32G	Metric cable gland M32	004482204	32	100
M-40G	Metric cable gland M40	004482205	58	50
M-50G	Metric cable gland M50	004482206	84	30
M-63G	Metric cable gland M63	004482207	147	16
M-12N	Metric lock nut M12	004482208	1	200
M-16N	Metric lock nut M16	004482209	1	200
M-20N	Metric lock nut M20	004482210	2	250
M-25N	Metric lock nut M25	004482211	3	800
M-32N	Metric lock nut M32	004482212	5	80
M-40N	Metric lock nut M40	004482213	6	50
M-50N	Metric lock nut M50	004482214	9	30
M-63N	Metric lock nut M63	004482215	15	10
M-12S	TP-M12 Metric sealing rubber washer M12	004482216	1,2	500
M-16S	TP-M16 Metric sealing rubber washer M16	004482217	1,5	500
M-20S	TP-M20 Metric sealing rubber washer M20	004482218	1,8	500
M-25S	TP-M25 Metric sealing rubber washer M25	004482219	2,1	300
M-32S	TP-M32 Metric sealing rubber washer M32	004482220	2,3	250
M-40S	TP-M40 Metric sealing rubber washer M40	004482221	2,6	150
M-50S	TP-M50 Metric sealing rubber washer M50	004482222	2,9	60
M-63S	TP-M63 Metric sealing rubber washer M63	004482223	4,1	50



